



USER MANUAL

ENGLISH | NEDERLANDS | DEUTSCH | FRANÇAIS | ESPAÑOL | ITALIANO | PORTUGUÊS

SAFESCAN TP-230

RECEIPT PRINTER

INTRODUCTION

This user manual shows you how to install and use your Safescan TP-230 thermal receipt printer. Please read these operating instructions carefully and keep this manual for future reference. For more information please see www.safescan.com.

PACKAGE CONTENTS

The retail box contains the following items:

- Safescan TP-230 Receipt printer
- Power adapter (7.5V/2A)
- Printing paper
- USB cable (USB-B to USB-A)
- Quick Install Guide

PRODUCT

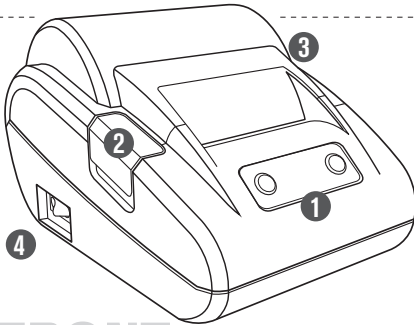

FRONT

1. Operation panel
2. Cover-open button
3. Paper cover
4. Power switch

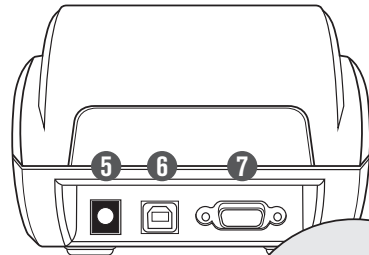

BACK

5. Power jack
6. USB connector
7. Serial (RS-232) connector
8. Thermal printing paper

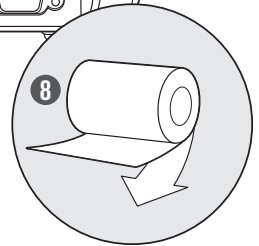

INSTALLING THE PRINTING PAPER

1. Open the cover by pushing the button

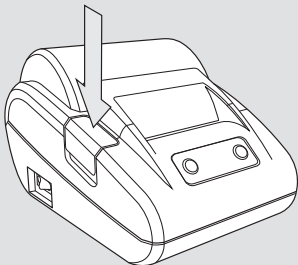

2. Place the paper roll as shown

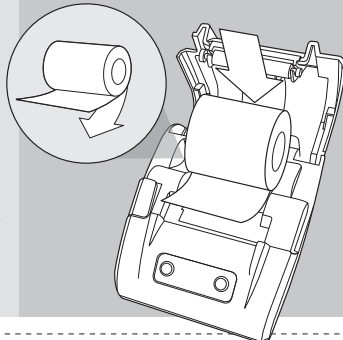

3. Close the cover

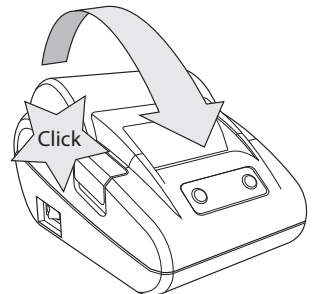

CONNECTING THE PRINTER

1. Connect the power adapter to the printer and the mains socket

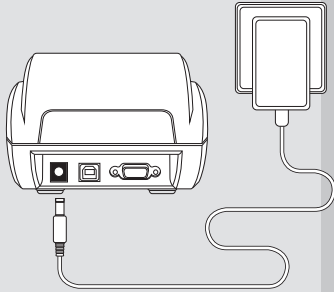

2. Connect the printer to your device via USB (cable supplied) or Serial port

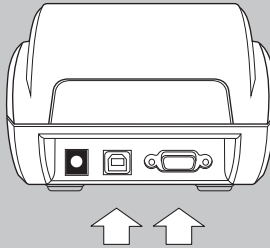

3. Switch on the power

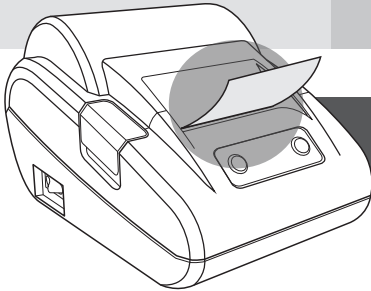
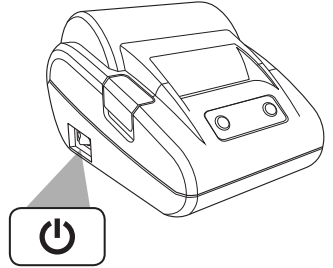

PLEASE NOTE: THE PAPER HAS TO BE PULLED OUT UNTIL IT IS VISIBLE OUTSIDE THE PRINTER BEFORE USE

BUTTONS AND LED INDICATORS

1. SET button; use this button to navigate through the printers' parameters, such as the interface, language and font size.
2. POWER led; indicates the printer is switched on.
3. ERROR led; will blink when an error occurs.
4. FEED button; use this button to feed paper and to select parameter settings.

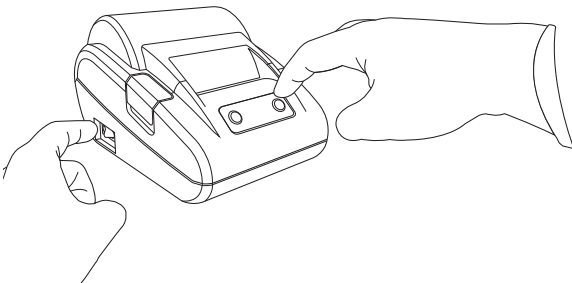
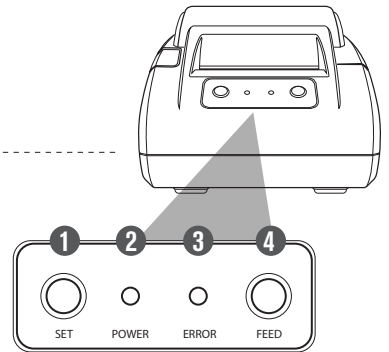

PRINTER SELF TEST

Press and hold the FEED button when turning on the power of the printer. The self-test receipt will now automatically be printed.

CHANGING THE PRINTER PARAMETER SETTINGS

By using the SET and FEED buttons you can navigate through various parameter setting menus. The printer will show which selection field has been selected by printing the selected parameter.

STEP 1. ENTER THE SETTING MODE

A. Switch off the power

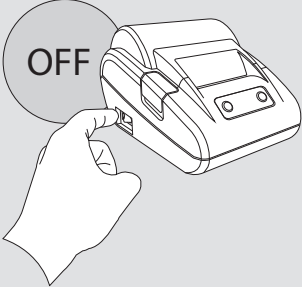

B. Press the SET and FEED buttons simultaneously

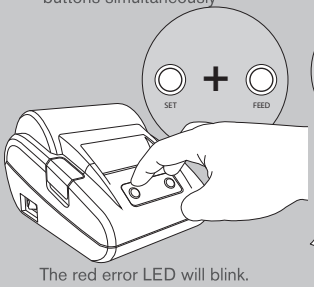

C. Switch on the power. Keep SET and FEED pressed

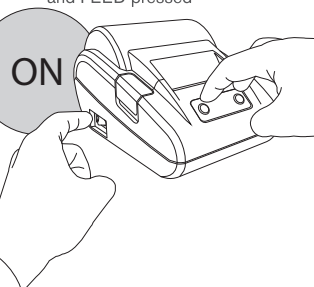

D. Release the FEED button whilst keeping SET pressed

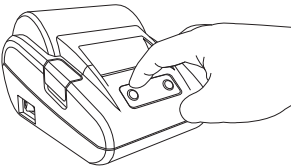

E. Press FEED twice whilst keeping SET pressed

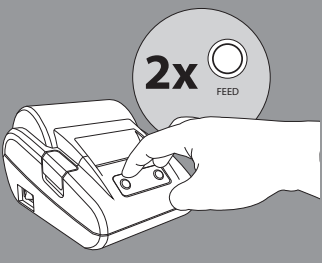

F. Release the SET button

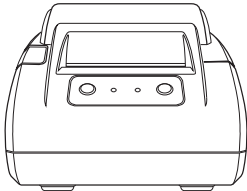

The printer is now in the **Parameter setup mode** and it will print the first parameter of the settings menu.

STEP 2. SELECT THE PARAMETER YOU WISH TO CHANGE

By pressing SET, you can scroll through the various items that can be changed. This sequence is a loop and is as follows:

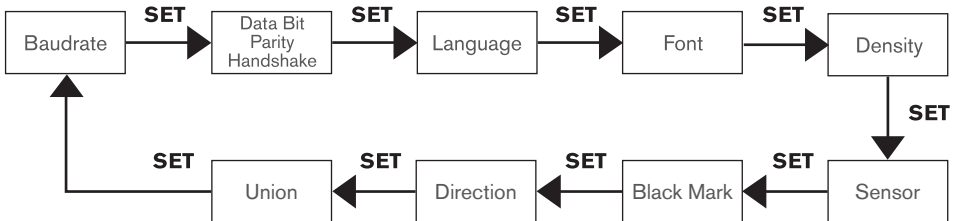

Every time you press SET, the printout will show which parameter is selected, plus its current setting. The next step shows how to change the setting.

STEP 3. CHANGE THE SETTING OF THE SELECTED ITEM

Once you are in the setting for the item you want to change, the desired value can be selected by pressing FEED. Every time you press FEED, the applicable value will be printed. The sequences are a loop and are as follows:

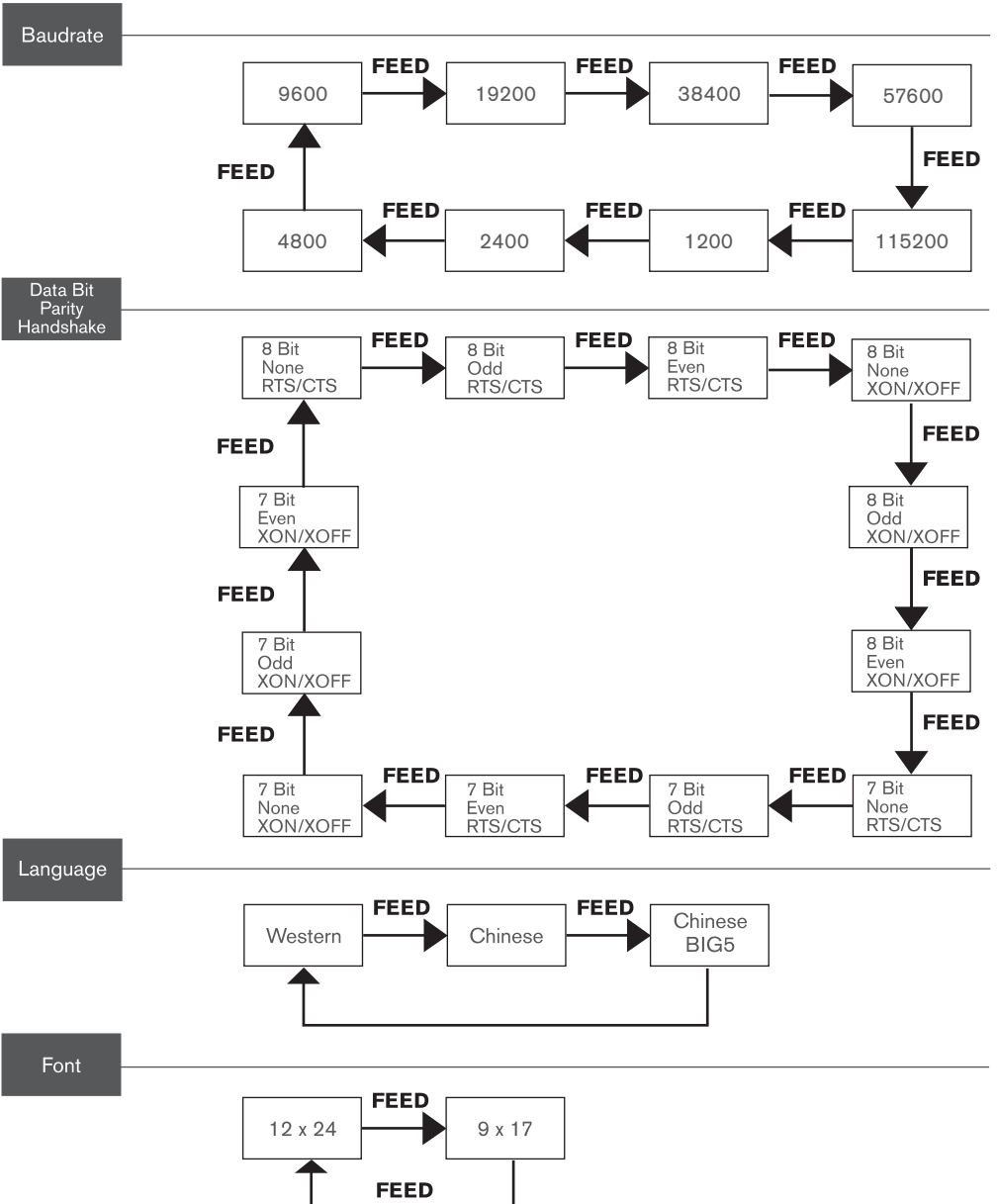

Density

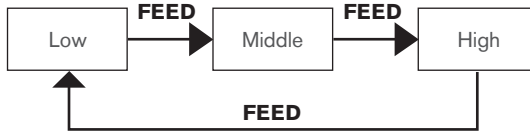

Sensor

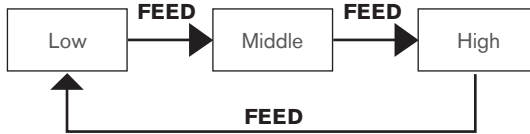

Black mark

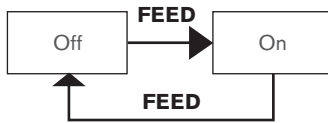

Direction

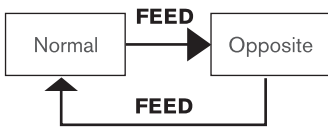

Union of orders



STEP 4. SAVE THE SETTINGS

When the changes are not saved, the printer will go back to default settings after it has been switched off. To save the settings:

A. Press both the SET and FEED button

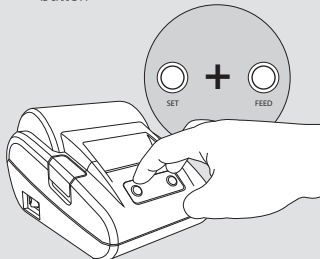

B. Release FEED while still pressing SET

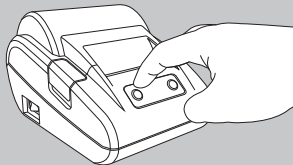

C. Release the SET button

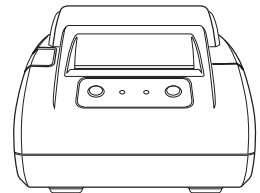

The printout will now show **Exit Set mode**. The settings have been saved.

SERIAL CABLE PIN CONNECTIONS

In case you need to connect your Safescan TP-230 with a RS 232 serial cable (not supplied) to a host device, the pin configuration layout is as follows:

PIN	SIGNAL	RESOURCE	DESCRIPTION
2	TXD	Printer	Printer to host send control code X-ON/X-OFF and data
3	RXD	Host	Printer receiving data from the host
5	GND	--	Signal ground
6	DSR	Printer	CTS
8	CTS	Printer	The signal for "MARK" status - printer "busy", not receiving data, and the signal for "SPACE" status - printer "ready", can receive data.

SUPPORT

DO YOU HAVE QUESTIONS OR DO YOU NEED TECHNICAL ASSISTANCE?

Please check first if the power adapter and data cable are connected properly, and whether the printing paper has been inserted correctly. Our tech support team is available by phone during office hours (GMT +1 timezone) or by e-mail to answer any question you may have regarding the use of your Safescan device. See www.safescan.com for details.

When calling or e-mailing our support center, always make sure you have the following information at hand: model number, partnumber, serial number (see product sticker at the bottom of the device), software version number, date of purchase.

TECHNICAL SPECIFICATIONS

Printing method: direct thermal
 Printing paper: width 58mm, thickness 0.06 ~ 0.08 mm
 Paper roll diameter: max. 60 mm
 Actual printing width: 48 mm
 Printing resolution: 8 dot /mm, 203dpi, 384 dots/line
 Printing speed: 60 mm/s

Interface: **RS232** interface: serial DB25, supports RTS/CTS protocol
 Baud rate: 2400, 4800, 9600, 19200, 38400, 57600, 115200bps
 Data structure: one start bit + 8 data bits + one or over one stop bit(s), no parity.

USB interface: USB B female

Power Supply: DC7.5V±10 / 2A

Operation temperature: 5° ~ 40° C / relative humidity: 10% ~80%
 Storage temperature: -20° ~ 60° C / relative humidity: 10% ~90%

Dimensions: 13.8 x 20×12 cm (L x W x H)
 Weight: 375 g (without paper roll inserted)

INTRODUCTIE

Deze gebruikshandleiding laat u zien hoe de Safescan TP-230 thermische bonprinter te installeren en te gebruiken. Lees deze instructies nauwgezet door en bewaar deze handleiding om later nog eens te kunnen raadplegen. Ga voor meer informatie naar www.safescan.com.

VERPAKKINGSINHOUD

De verpakking bevat de volgende items:

- Safescan TP-230 bonprinter
- Netstroomadapter (7.5V/2A)
- Printpapier
- USB kabel (USB-B naar USB-A)
- Gebruikshandleiding

PRODUCT

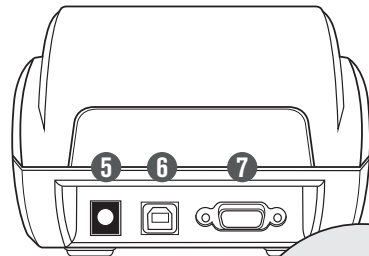
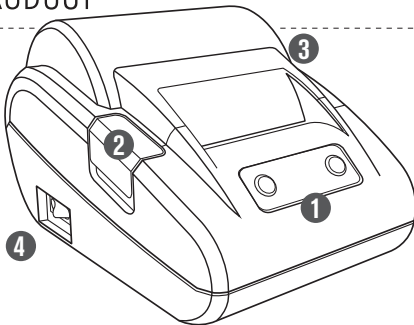

VOORZIJD

1. Bedieningspaneel
2. Printer klep openen
3. Papier uitvoer
4. Aan/uit schakelaar

ACHTERZIJD

5. Netstroom aansluiting
6. USB aansluiting
7. Seriéle (RS-232) aansluiting
8. Thermisch printpapier

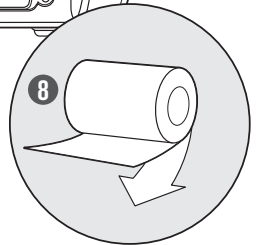

PRINT PAPIER INSTALLEREN

1. Open de klep van de printer door op deze knop te drukken

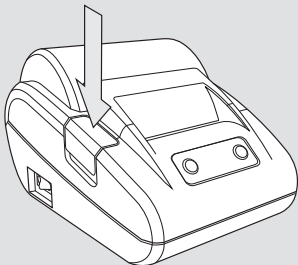

2. Plaats het papier zoals getoond

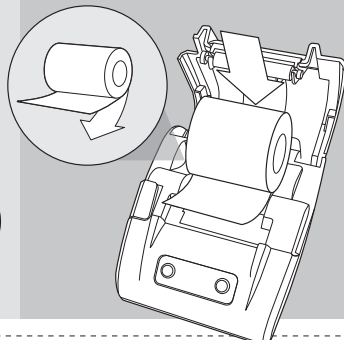

3. Sluit de klep

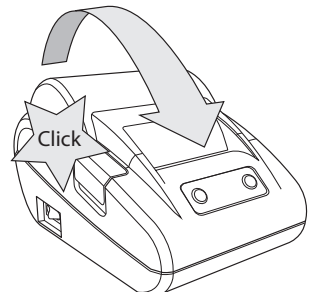

DE PRINTER AANSLUITEN

1. Sluit de netstroomadapter aan op de printer en op het stopcontact

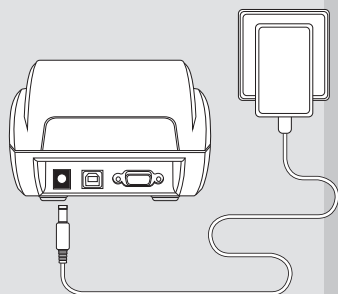

2. Sluit de printer aan op het gewenste apparaat via USB (kabel bijgeleverd) of seriële poort

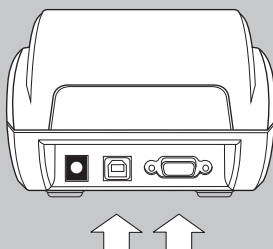

3. Zet de printer aan

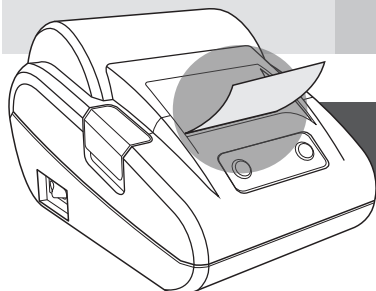
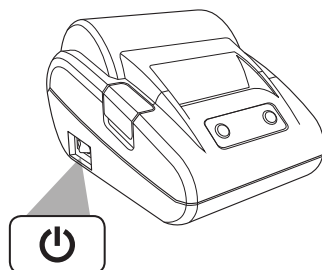

LET OP: VOOR GEBRUIK MOET HET PAPIER EEN STUKJE UITGETROKKEN WORDEN TOTDAT HET ZICHTBAAR IS VANAF DE BUITENKANT

BEDIENINGSKNOPPEN EN LED LAMPJES

1. SET knop; gebruik deze om door de parameters van de printer te bladeren zoals interface, taal en fontgrootte.
2. AAN/UIT led; brandt wanneer de printer aan staat.
3. FOUT led; gaat knipperen als er een storing is.
4. FEED knop; gebruik deze om het papier door te voeren en om parameter instellingen te wijzigen.

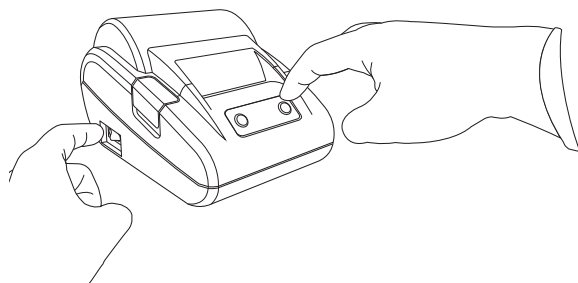
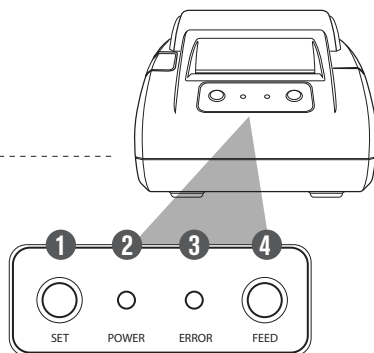

PRINTER ZELFTEST

Druk op FEED en houdt deze ingedrukt terwijl u de printer aanzet. Het zelftest rapport zal nu automatisch worden afgedrukt.

DE PRINTER PARAMETER INSTELLINGEN VERANDEREN

Met behulp van de SET en FEED knoppen kunt u door de diverse parameter instellingsmenu's bladeren. De printer toont u welk selectieveld is gekozen door de geselecteerde parameter af te drukken.

STAP 1. DE INSTELLINGSMODUS ACTIVEREN

A. Zet de printer uit

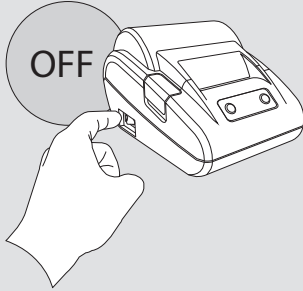

B. Druk tegelijkertijd op de SET en FEED knoppen

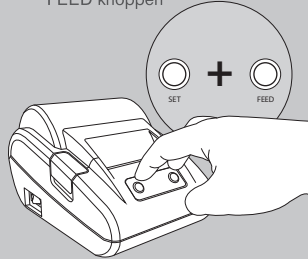

Het rode LED lampje gaat knipperen

C. Zet de printer aan, houd SET en FEED ingedrukt

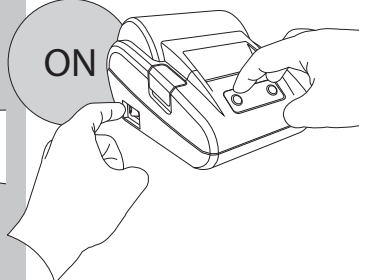

D. Laat de FEED knop los, maar houd de SET knop ingedrukt

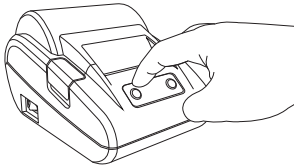

E. Druk twee keer op FEED terwijl de SET knop ingedrukt blijft

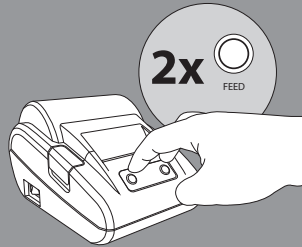

F. Laat de SET knop los

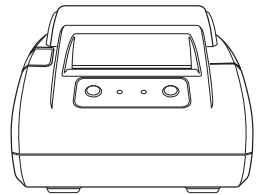

De printer staat nu in de **Parameter Instelmodus** en zal "Parameter setup mode" afdrukken.

STAP 2. SELECTEER DE TE WIJZIGEN PARAMETER

Door herhaaldelijk op SET te drukken bladert u door de diverse items die veranderd kunnen worden. De volgorde is wederkerig en is als volgt:

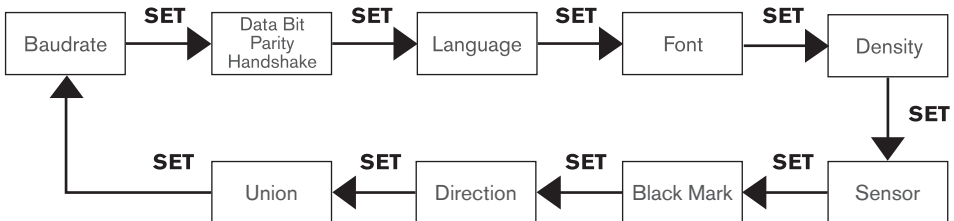
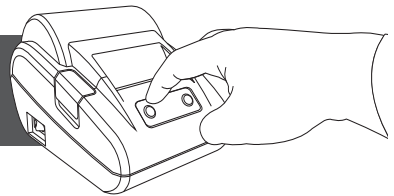

Elke keer wanneer u op SET drukt zal de printout u laten zien welke parameter is geselecteerd, inclusief de bijbehorende huidige instelling. De volgende stap laat zien hoe deze instelling te wijzigen.

STAP 3. DE INSTELLING VAN HET GESELECTEERDE ITEM WIJZIGEN

Wanneer u bent beland bij het item dat u wenst te wijzigen, kunt u de gewenste waarde selecteren door herhaaldelijk op FEED te drukken. Elke keer dat u op FEED drukt zal de bijbehorende waarde worden afgedrukt. De volgorde is wederkerig en is als volgt:

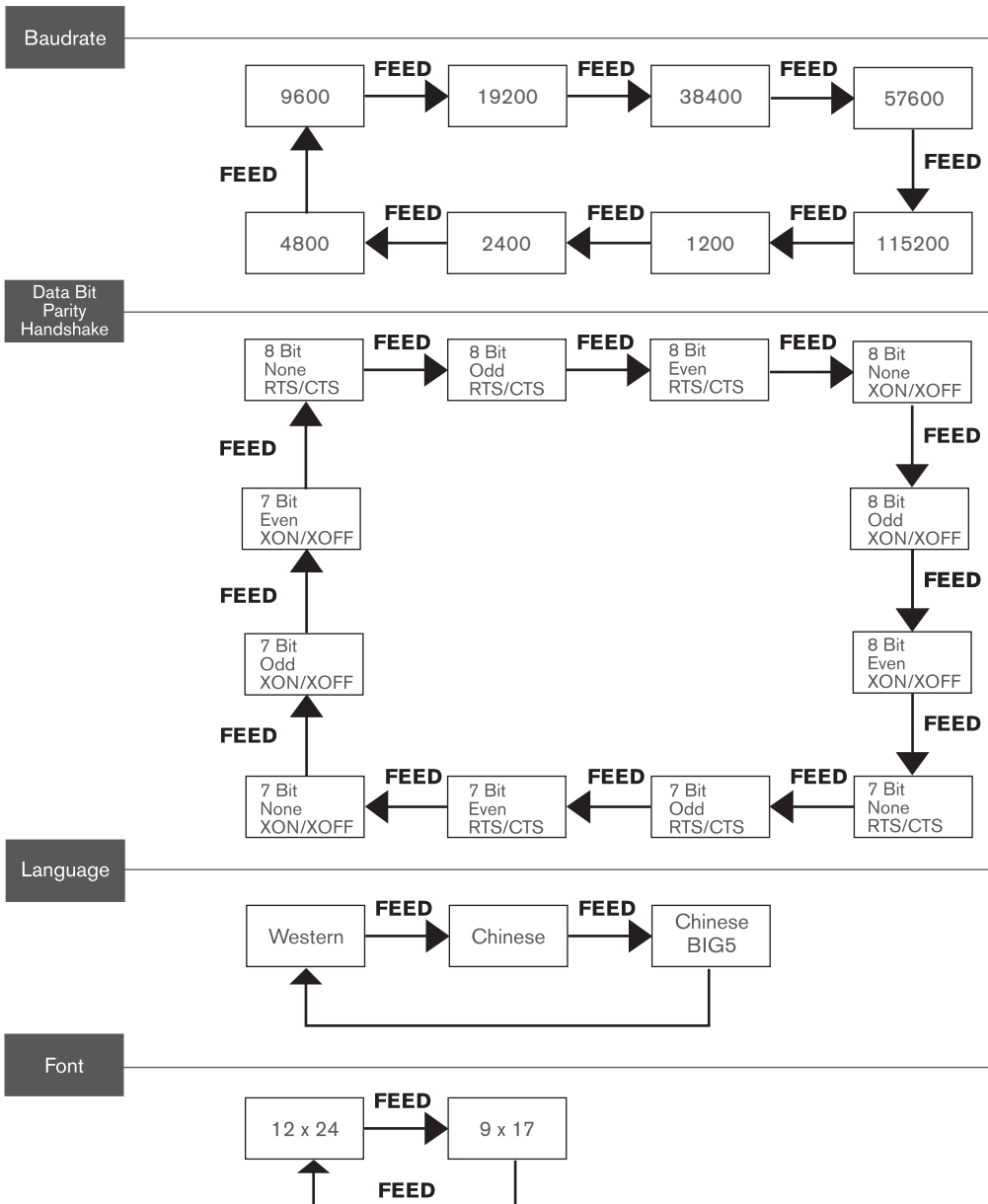

Density

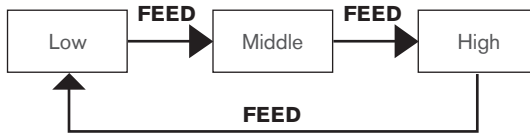

Sensor



Black mark

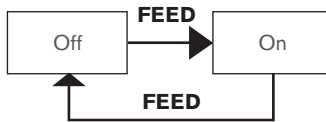

Direction

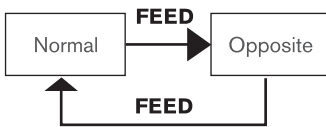

Union of orders



STAP 4. DE INSTELLINGEN OPSLAAN

Als u de wijzigingen niet opslaat zal de printer na uitschakelen terugkeren naar de standaardinstellingen. Om wijzigingen op te slaan:

A. Druk SET en FEED tegelijkertijd in

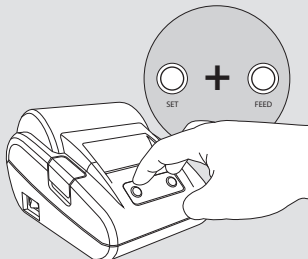

B. Laat FEED los terwijl u SET ingedrukt houdt

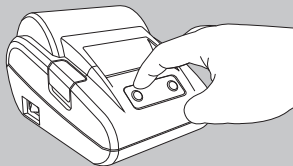

C. Laat de SET knop los

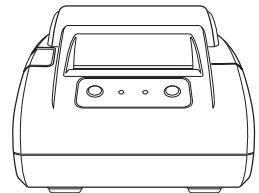

Op de printout zal nu **Exit Set mode** worden afgedrukt. De instellingen zijn nu opgeslagen.

PIN AANSLUITINGEN VAN DE SERIËLE POORT

Wanneer u de Safescan TP-230 met een RS 232 seriële kabel (niet bijgeleverd) op een "host"-apparaat wilt aansluiten is de pin configuratie als volgt:

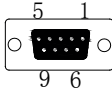
PIN		SIGNAAL	BRON	OMSCHRIJVING
2		TXD	Printer	Printer naar host controle zendcode X-ON/X-OFF en data
3		RXD	Host	Printer ontvangt data van de host
5		GND	--	Aarde signaal
6		DSR	Printer	CTS
8		CTS	Printer	Het "MARK" status signaal - printer is "busy", ontvangt geen data, en het "SPACE" status signaal - printer is "ready", kan data ontvangen.

SUPPORT

HEEFT U VRAGEN OF HEEFT U TECHNISCHE ONDERSTEUNING NODIG?

Controleer eerst of de netstroomadapter en aansluitkabel correct zijn aangesloten, en of het printpapier correct in de printer zit. Onze helpdeskmedewerkers zijn per telefoon bereikbaar gedurende kantooruren (GMT +1 tijdszone) of via e-mail om elke vraag die u mogelijkzwerijs heeft over het gebruik van uw Safescan product te beantwoorden. Ga naar www.safescan.com voor meer informatie.

Wanneer u met onze helpdesk belt of mailt, zorg er dan altijd voor dat u de volgende informatie bij de hand heeft: modelnummer, artikelnummer, serienummer (zie productsticker op de onderzijde van het apparaat), software versienummer en de datum van aankoop.

TECHNISCHE SPECIFICATIES

Printmethode: direct thermisch
 Printpapier: 58mm breed, 0.06 ~ 0.08 mm dik
 Papierrol diameter: max. 60 mm
 Afdrukbreedte: 48 mm
 Printresolutie: 8 dots /mm, 203dpi, 384 dots/line
 Printsnelheid: 60 mm/s

Interface: **RS232** interface: serieel DB25, ondersteunt het RTS/CTS protocol
 Baud rate: 2400, 4800, 9600, 19200, 38400, 57600, 115200bps
 Datastructuur: één startbit + 8 data bits + één of meer stopbit(s), geen parity.

USB interface: USB B female

Voeding: DC7.5V±10 / 2A

Bedrijfstemperatuur: 5° ~ 40° C / relatieve luchtvochtigheid: 10% ~80%
 Opslagtemperatuur: -20° ~ 60° C / relatieve luchtvochtigheid: 10% ~90%

Afmetingen: 13.8 x 20x12 cm (B x D x H)
 Gewicht: 375 g (zonder papierrol in de printer)

EINLEITUNG

Diese Gebrauchsanleitung erklärt Ihnen, wie Sie Ihren Safescan TP-230 Thermoquittungsdrucker installieren und verwenden. Bitte lesen Sie sich die Betriebsanleitung sorgfältig durch und bewahren Sie diese Anleitung für zukünftige Hinweise auf. Weitere Informationen finden Sie unter www.safescan.com.

VERPACKUNGSIHALT

Die Produktpackung enthält Folgendes:

- Safescan TP-230 Quittungsdrucker
- Netzteil (7.5V/2A)
- Druckpapier
- USB-Kabel (USB-B an USB-A)
- Anleitung für den Schnellstart

PRODUKT

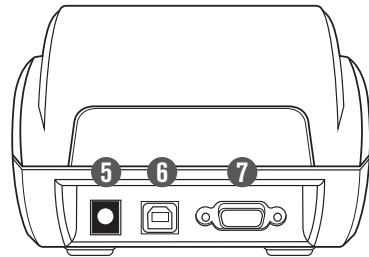
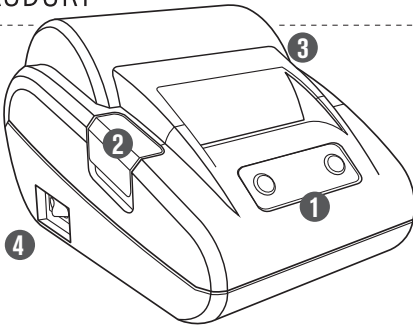

VORDERSEITE

1. Bedienfeld
2. Taste zum Öffnen der Abdeckung
3. Papiereinzug
4. Netzschalter

RÜCKSEITE

5. Netzstecker
6. USB-Anschluss
7. Serieller (RS-232) Anschluss
8. Thermoquittungspapier

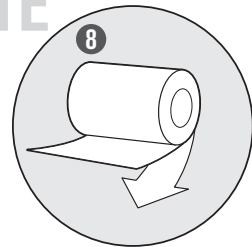

INSTALLATION DES DRUCKPAPIERS

1. Öffnen Sie die Abdeckung, indem Sie die Taste drücken

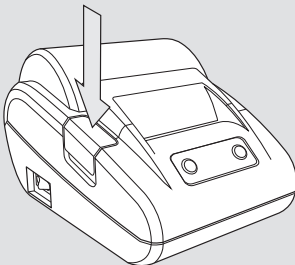

2. Legen Sie die Papierrolle wie abgebildet ein

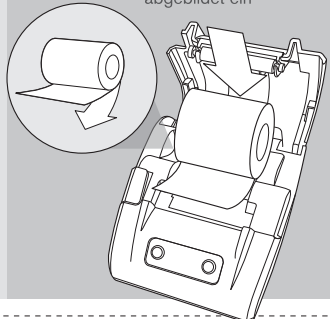

3. Schließen Sie die Abdeckung

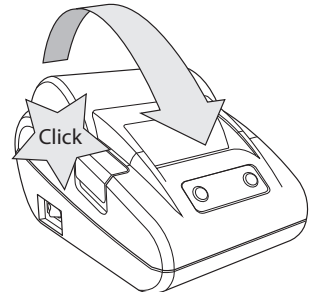

VERBINDEN DES DRUCKERS

- 1.** Schließen Sie das Netzteil an den Drucker und die Steckdose an

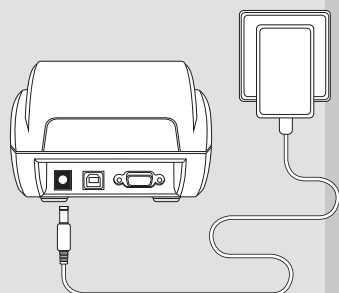

- 2.** Schließen Sie den Drucker an Ihr Gerät über eine USB (Kabel im Lieferumfang enthalten) oder eine serielle Schnittstelle an

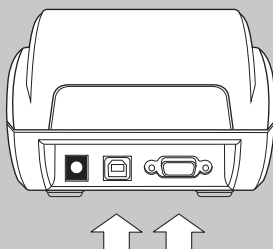

- 3.** Schalten Sie das Gerät ein

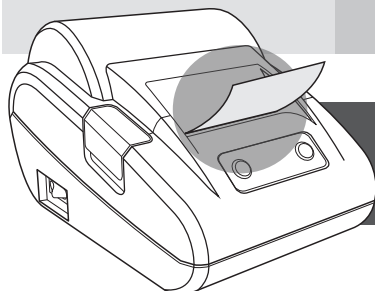
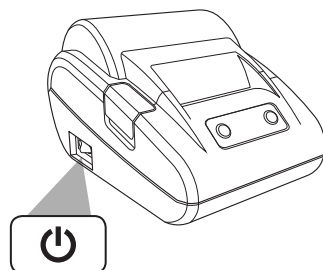

BITTE BEACHTEN: DAS PAPIER MUSS VOR VERWENDUNG HERAUSGEZOGEN WERDEN, BIS ES AUSSERHALB DES DRUCKERS SICHTBAR IST

TASTEN UND LED-ANZEIGEN

- 1.** SET-Taste; verwenden Sie diese Taste, um durch die Parameter des Druckers zu navigieren, wie beispielsweise die Schnittstelle, Sprache und Schriftgröße.
- 2.** POWER -Led; zeigt an, dass der Drucker eingeschaltet ist.
- 3.** ERROR-Led; blinkt, wenn ein Fehler auftritt.
- 4.** FEED-Taste; verwenden Sie diese Taste, um Papier einzuführen und um Parametereinstellungen zu wählen.

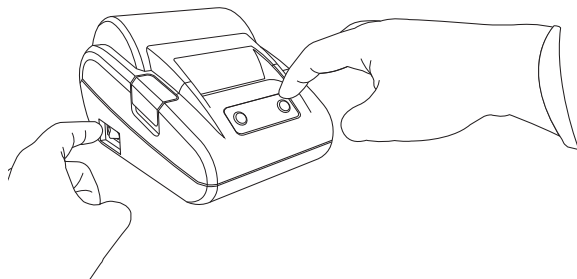
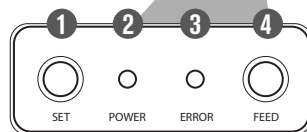
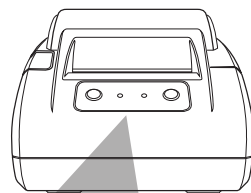

DRUCKERSELBSTTEST

Drücken und halten Sie die FEED-Taste beim Einschalten der Stromversorgung des Druckers. Die Selbsttest-Quittung wird nun automatisch ausgedruckt.

ÄNDERN DER DRUCKER-PARAMETEREINSTELLUNGEN

Durch die Verwendung der SET- und FEED-Taste können Sie durch die verschiedenen Parametereinstellungs-Menüs navigieren. Der Drucker wird anzeigen, welches Auswahlfeld durch Drücken der ausgewählten Parameter ausgewählt wurde.

SCHRITT 1. GEBEN SIE DEN EINSTELLMODUS EIN

A. Schalten Sie den Strom aus

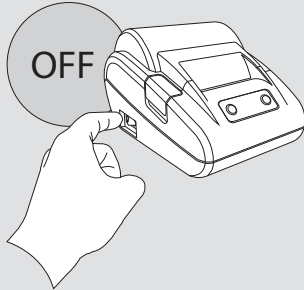

B. Drücken Sie die SET- und FEED-Taste gleichzeitig

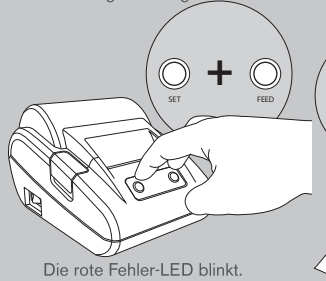

C. Schalten Sie den Strom an. Halten Sie SET und FEED gedrückt

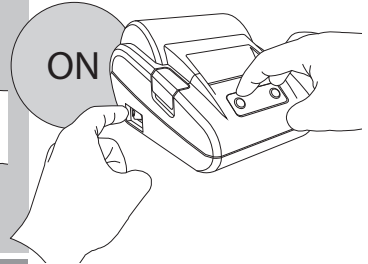

D. Lassen Sie die FEED-Taste los, während Sie SET gedrückt halten

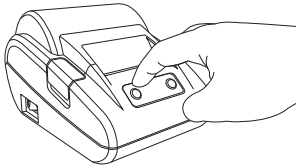

E. Drücken Sie zweimal auf FEED während Sie SET gedrückt halten

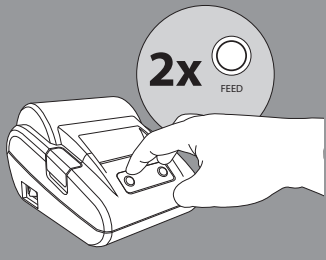

F. Lassen Sie die SET-Taste los

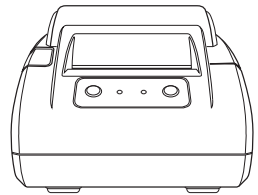

Der Drucker ist jetzt im **Parameter-Set-up-Modus** und druckt den ersten Parameter des Einstellmenüs.

SCHRITT 2. WÄHLEN SIE DEN PARAMETER AUS, DEN SIE ÄNDERN WOLLEN

Durch Drücken von SET können Sie durch die verschiedenen Elemente scrollen, die geändert werden können. Diese Sequenz ist eine Schleife und ist wie folgt:

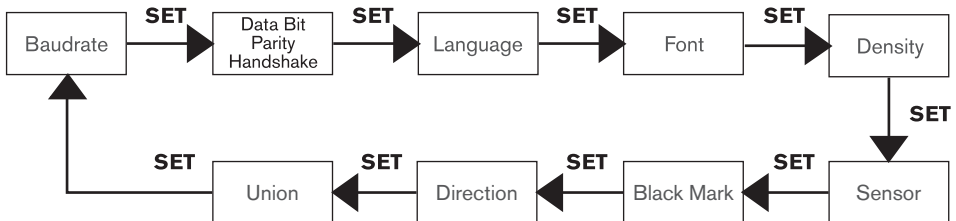
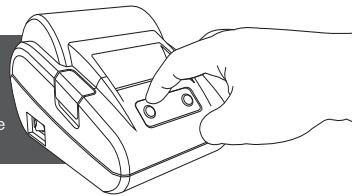

Jedes Mal, wenn Sie SET drücken, wird der Ausdruck anzeigen, welche Parameter ausgewählt sind, sowie seine aktuelle Einstellung. Der nächste Schritt erklärt, wie man die Einstellung ändert.

SCHRITT 3. ÄNDERN DER EINSTELLUNG DES AUSGEWÄHLTEN ELEMENTS

Wenn Sie in der Einstellung für das Element sind, das Sie ändern möchten, können Sie den gewünschten Wert durch Drücken auf FEED auswählen. Jedes Mal, wenn Sie FEED drücken, wird der entsprechende Wert ausgedruckt. Die Sequenzen sind eine Schleife und sind wie folgt:

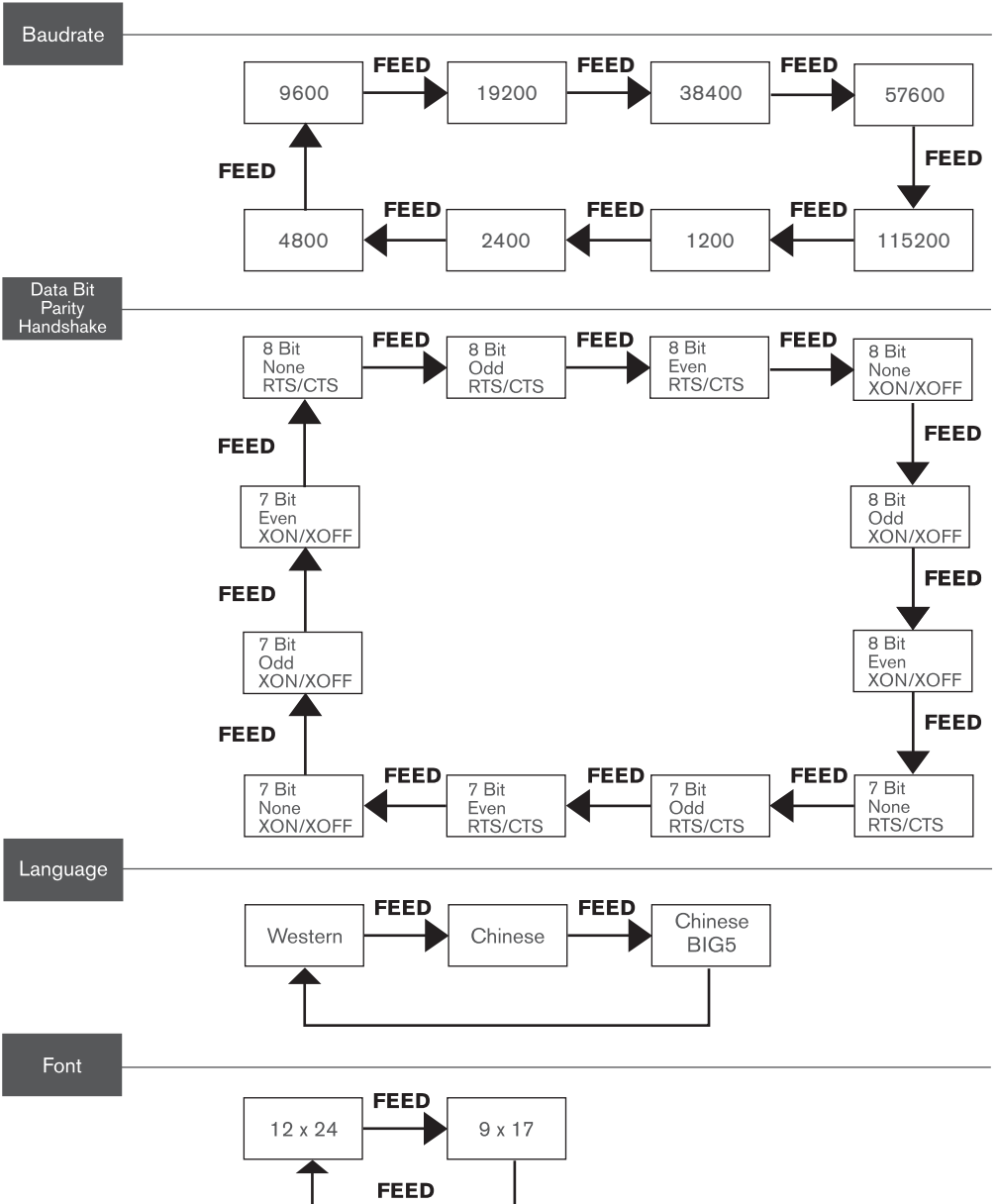

Density

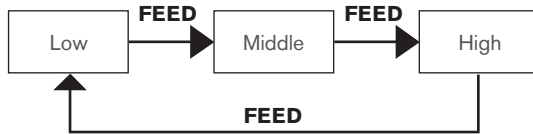

Sensor



Black mark

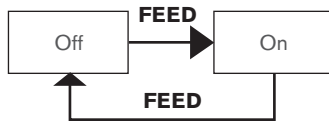

Direction

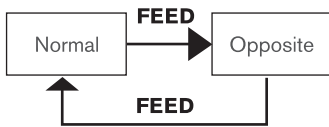

Union of orders



SCHRITT 4. SPEICHERN SIE DIE EINSTELLUNGEN

Wenn die Änderungen nicht gespeichert werden, stellt sich der Drucker zurück auf die Werkseinstellungen, nachdem er ausgeschaltet wurde. Um die Einstellungen zu speichern:

- A.** Drücken Sie sowohl SET als auch die FEED-Taste

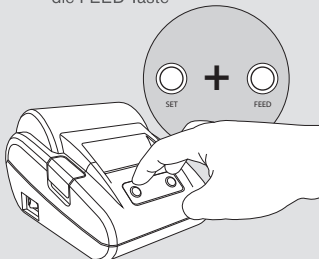

- B.** Lassen Sie FEED los und drücken weiterhin auf SET

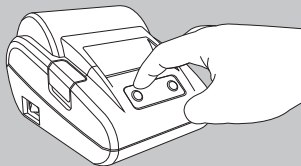

- C.** Lassen Sie die SET-Taste los

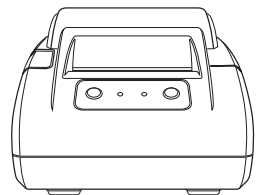

Der Ausdruck wird nun **Exit Set mode** anzeigen. Die Einstellungen wurden gespeichert.

SERIELLE KABEL-PIN-VERBINDUNGEN

Falls Sie Ihren Safescan TP-230 mit einem seriellen RS 232-Kabel (nicht mitgeliefert) an ein Host-Gerät anschließen müssen, ist das Pin-Konfigurations-Layout wie folgt:

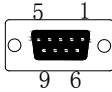
PIN		SIGNAL	RESSOURCE	BESCHREIBUNG
2		TXD	Drucker	Drucker sendet zum Host Steuercodes X-ON/X-OFF und Daten
3		RXD	Host	Drucker empfängt Daten vom Host
5		GND	--	Signalmasse
6		DSR	Drucker	CTS
8		CTS	Drucker	Das Signal für den „MARK“-Status - Drucker ist „beschäftigt“, er empfängt keine Daten; und das Signal für den „SPACE“-Status - Drucker ist „bereit“, er kann Daten empfangen.

SUPPORT

NOCH FRAGEN? BENÖTIGEN SIE TECHNISCHE UNTERSTÜTZUNG?

Bitte überprüfen Sie zuerst, ob das Netzteil und Datenkabel richtig angeschlossen ist und ob das Druckpapier richtig eingelegt wurde. Unser technisches Support-Team ist telefonisch während der Bürozeiten (GMT +1 Zeitzone) oder per E-Mail erreichbar, um alle Ihre Fragen zu beantworten, die Sie zur Verwendung Ihres Safescan-Geräts haben. Siehe www.safescan.com für Details.

Bitte halten Sie bei einem Anruf oder bei einem E-Mail-Kontakt mit unserem Support-Center die folgenden Informationen bereit: Modellnummer, Teilenummer, Seriennummer (siehe Produktaufkleber auf der Unterseite des Geräts), Software-Version, Kaufdatum.

TECHNISCHE SPEZIFIKATIONEN

Druckverfahren:	Thermodirekt
Druckpapier:	Breite 58mm, Dicke 0.06 ~ 0.08 mm
Papierrollen-Durchmesser:	max. 60 mm
Tatsächliche Druckbreite:	48 mm
Druckauflösung:	8 Punkte /mm, 203dpi, 384 Punkte/Zeile
Druckgeschwindigkeit:	60 mm/s

Schnittstelle: **RS232**-Schnittstelle: seriell DB25 unterstützt RTS/CTS-Protokoll
 Baud-Rate: 2400, 4800, 9600, 19200, 38400, 57600, 115200bps
 Datenstruktur: ein Startbit + 8 Datenbits + einen oder mehr als einen Stop-Bit(s), keine Parität.

USB-Schnittstelle: USB-B-Buchse

Netzteil: DC7.5V±10 / 2A

Betriebstemperatur: 5° ~ 40° C / relative Luftfeuchtigkeit: 10% ~80%
 Lagerungstemperatur: -20° ~ 60° C / relative Luftfeuchtigkeit: 10% ~90%

Abmessungen: 13,8 x 20x12 cm (L x B x H)
 Gewicht: 375 g (ohne eingelegte Papierrolle)

INTRODUCTION

Ce guide de l'utilisateur vous indique comment installer et utiliser votre imprimante thermique Safescan TP-230. Veuillez lire ces instructions d'utilisation et les conserver pour les consulter ultérieurement. Pour plus d'informations veuillez visiter www.safescan.com.

CONTENU DU PACK

L'emballage contient les éléments suivants :

- Imprimante de reçus Safescan TP-230
- Adaptateur secteur (7,5V/2A)
- Câble USB (USB B à USB A)
- Guide d'installation rapide

PRODUIT

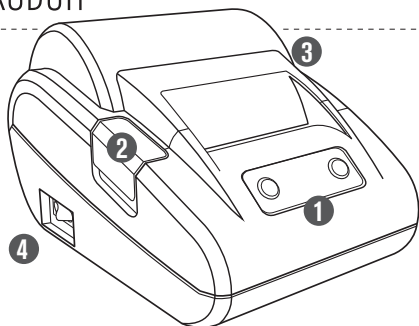

AVANT

1. Panneau de commande
2. Bouton d'ouverture du couvercle
3. Couvercle pour le papier
4. Interrupteur

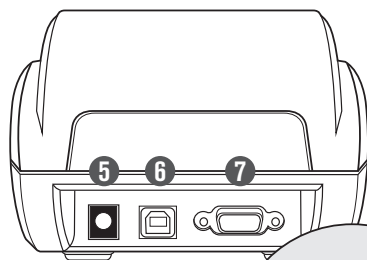

ARRIÈRE

5. Prise de courant
6. connecteur USB
7. Connecteur série (RS-232)
8. Papier thermique

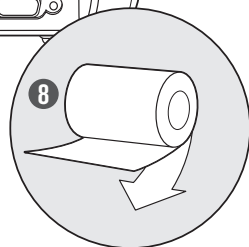

INSTALLATION DU PAPIER

1. Ouvrez le couvercle en appuyant sur le bouton

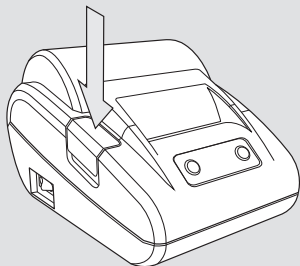

2. Disposez le rouleau de papier comme indiqué

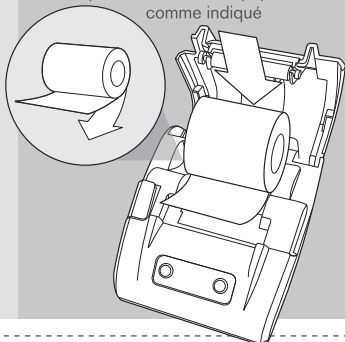

3. Fermez le couvercle

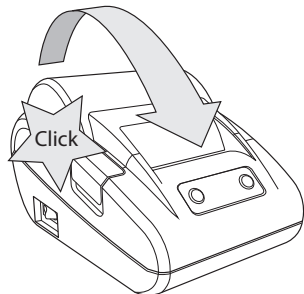

CONNEXION DE L'IMPRIMANTE

1. Branchez l'adaptateur secteur à l'imprimante et à la prise de courant

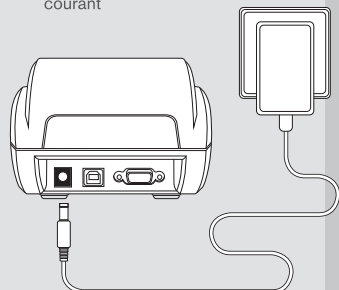

2. Branchez l'imprimante à votre appareil via USB (câble fourni) ou par port série

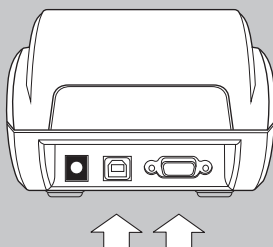

3. Mettez sous tension

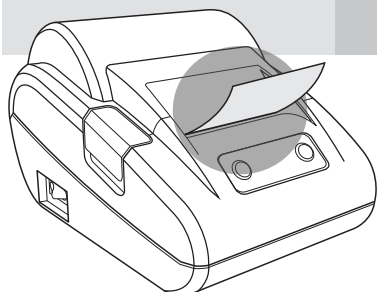
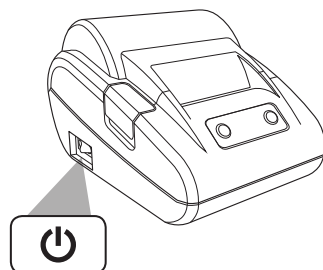

BOUTONS ET VOYANTS LUMINEUX

1. Bouton SET, utilisez ce bouton pour naviguer à travers les paramètres de l'imprimante, tels que l'interface, la langue et la taille de la police.
2. Voyant POWER, indique que l'imprimante est sous tension.
3. Voyant ERROR, clignote en cas d'erreur.
4. Bouton FEED, utilisez ce bouton pour alimenter le papier et pour sélectionner les paramètres.

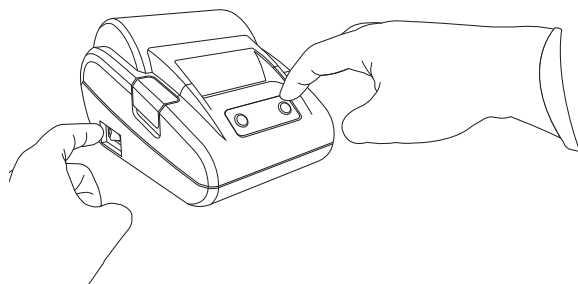
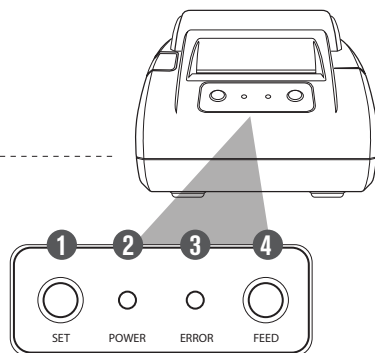

AUTO-TEST DE L'IMPRIMANTE

Appuyez et maintenez le bouton FEED enfoncé lorsque vous mettez l'imprimante sous tension. Le reçu d'auto-test s'imprimera automatiquement.

CHANGEMENT DES PARAMÈTRES DE L'IMPRIMANTE

Au moyen des boutons SET et FEED vous pouvez naviguer à travers les différents paramètres des menus de réglage. L'imprimante affichera le champ de sélection choisi en imprimant le paramètre sélectionné.

ÉTAPE 1 ENTREZ DANS LE MODE RÉGLAGE

A. Mettez hors tension

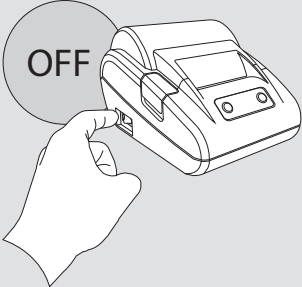

B. Appuyez simultanément sur les boutons SET et FEED

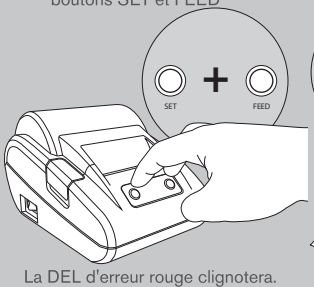

La DEL d'erreur rouge clignotera.

C. Mettez sous tension. Maintenez SET et FEED enfoncés

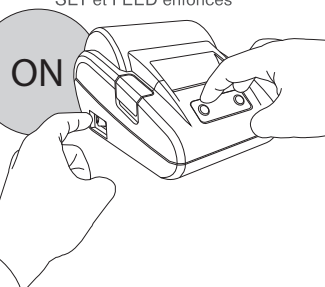

D. Relâchez le bouton FEED tout en maintenant le bouton SET appuyé

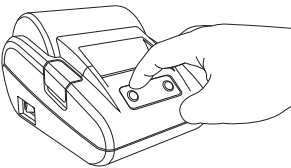

E. Appuyez deux fois sur FEED tout en maintenant le bouton SET appuyé

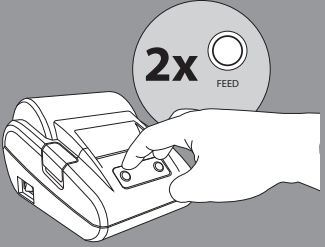

F. Relâchez le bouton SET

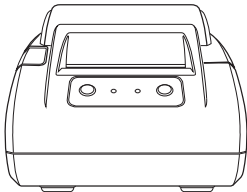

L'imprimante est désormais en mode **Configuration des paramètres** et imprimera le premier paramètre du menu de réglages.

ÉTAPE 2 SÉLECTIONNEZ LE PARAMÈTRE QUE VOUS SOUHAITEZ MODIFIER

En appuyant sur SET vous pouvez faire défiler les différents éléments modifiables. Cette séquence forme une boucle et se présente comme suit :

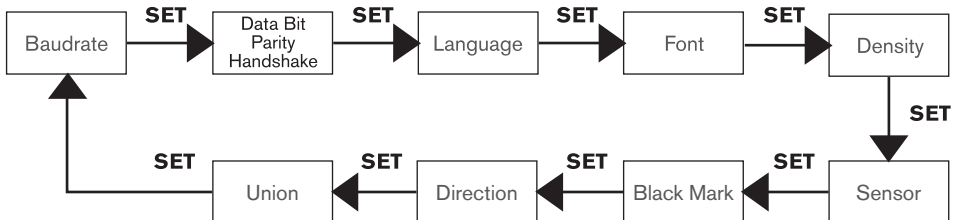
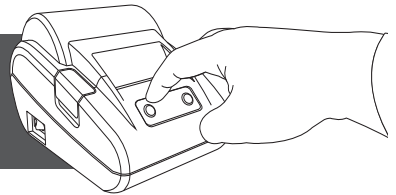

À chaque fois que vous appuyez sur SET, l'impression indiquera quel paramètre est sélectionné ainsi que son réglage actuel. La prochaine étape montre comment changer le réglage.

ÉTAPE 3 CHANGEMENT DU PARAMÈTRE DE L'ÉLÉMENT INDICQUÉ

Une fois que vous êtes au paramètre de l'élément que vous souhaitez changer, la valeur souhaitée peut être sélectionnée en appuyant sur FEED. À chaque pression du bouton FEED, la valeur applicable sera imprimée. Les séquences forment une boucle et se présentent comme suit :

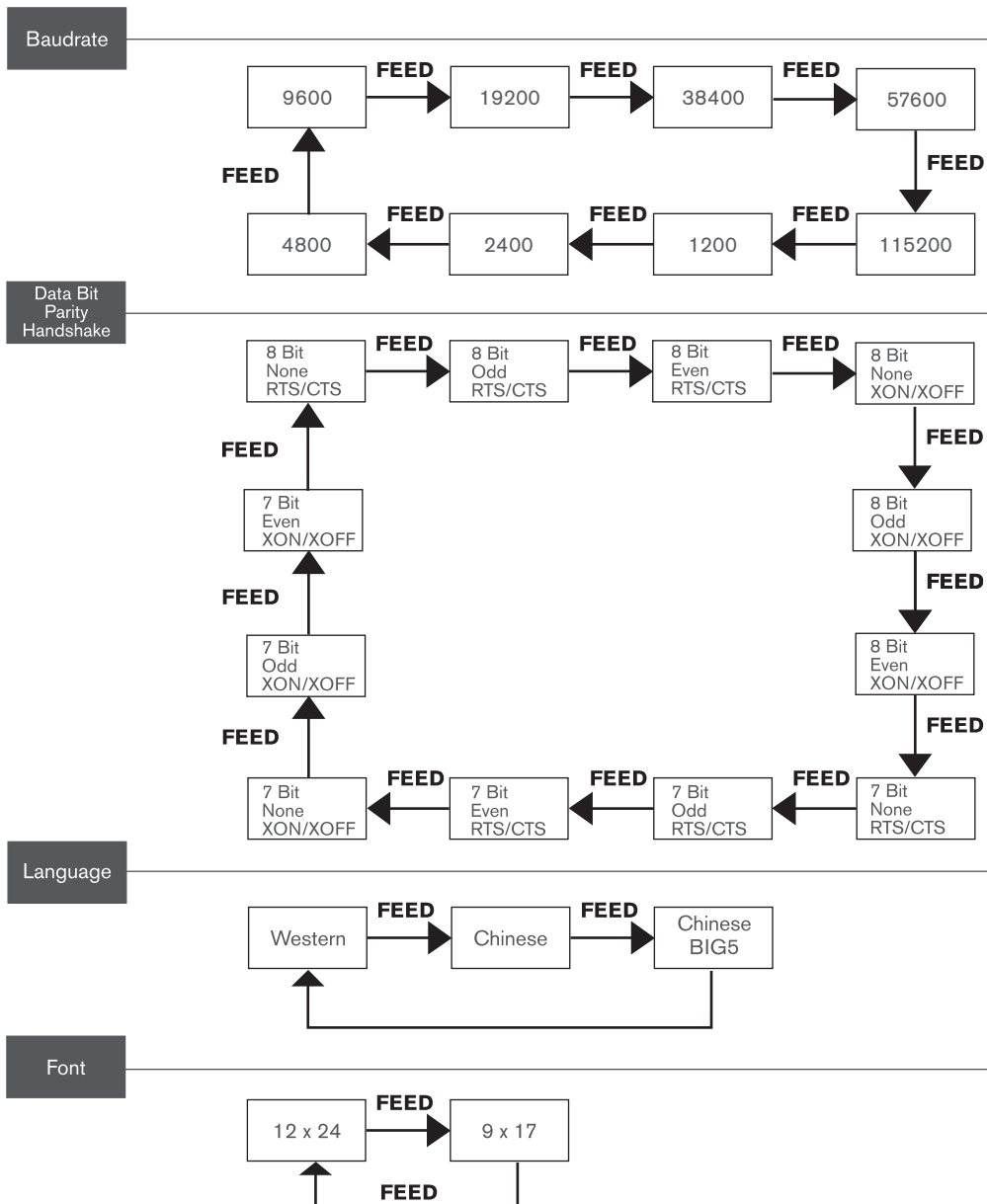

Density

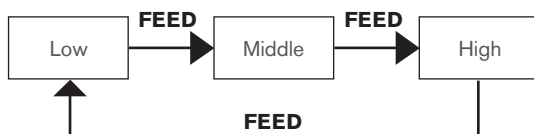

Sensor

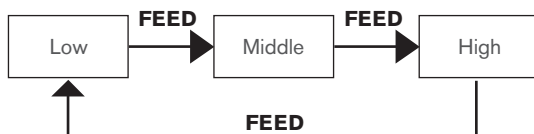

Black mark

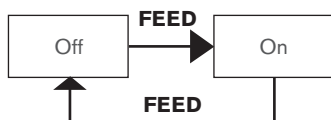

Direction

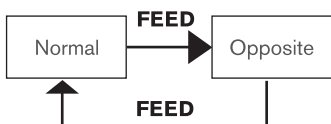

Union of orders

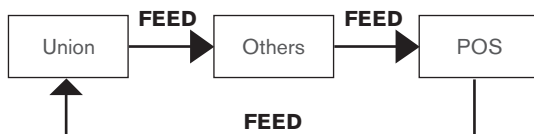

ÉTAPE 4 ENREGISTRER LES PARAMÈTRES

Lorsque les modifications ne sont pas enregistrées, l'imprimante reviendra aux réglages par défaut si elle est éteinte.

Pour enregistrer les paramètres :

A. Appuyez sur les deux boutons SET et FEED

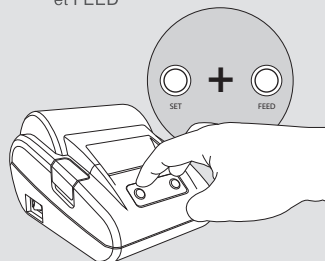

B. Relâchez le bouton FEED tout en maintenant SET

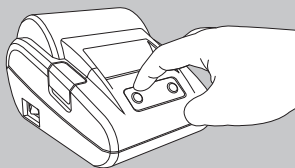

C. Relâchez le bouton SET

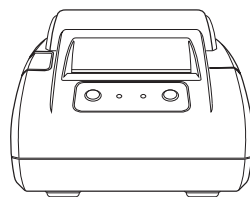

L'impression affichera désormais **Exit Set mode**. Les paramètres ont été enregistrés.

RACCORDEMENTS PAR CÂBLE SÉRIE À BROCHES

Au cas où vous auriez besoin de raccorder votre Safescan TP-230 au moyen d'un câble série RS 232 (non fourni) à un périphérique hôte, la disposition des broches se présente comme suit :

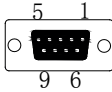
BROCHE		SIGNAL	RESSOURCE	DESCRIPTION
2		TXD	Imprimante	Envoi de données et du code de commande X-ON/X-OFF de l'imprimante à l'hôte
3		RXD	Hôte	Réception des données de l'hôte par l'imprimante
5		GND	--	Masse signal
6		DSR	Imprimante	CTS
8		CTS	Imprimante	Le signal pour l'état « MARK » - l'imprimante est « occupée », ne recevant pas les données, et le signal pour l'état « SPACE » - l'imprimante est « prête », peut recevoir des données.

ASSISTANCE

VOUS AVEZ DES QUESTIONS ? VOUS AVEZ BESOIN D'UNE ASSISTANCE TECHNIQUE ?

Veillez d'abord vérifier si l'adaptateur secteur et le câble de données sont correctement raccordés et si le papier d'impression a bien été inséré. Notre équipe d'assistance technique est disponible par téléphone aux heures d'ouverture de bureau (fuseau horaire GMT +1) ou par e-mail pour répondre à toutes vos questions concernant l'utilisation de votre appareil Safescan. Visitez www.safescan.com pour plus de détails.

Lorsque vous appelez ou envoyez un e-mail à notre centre d'assistance, veuillez vous assurer de disposer des informations suivantes sous la main : numéro de modèle, référence, numéro de série (voir l'étiquette du produit en dessous de l'appareil), le numéro de version du logiciel, la date d'achat.

SPÉCIFICATIONS TECHNIQUES

Méthode d'impression :	thermique directe
Papier d'impression :	largeur 58 mm, épaisseur 0,06~0,08 mm
Diamètre du rouleau de papier :	60 mm max.
Largeur d'impression réelle :	48 mm
Résolution d'impression :	8 points/mm, 203 ppp, 384 points/ligne
Vitesse d'impression :	60 mm/s
Interface :	interface RS232 : série DB25, prise en charge du protocole RTS/CTS Débit en bauds : 2400, 4800, 9600, 19200, 38400, 57600, 115200 bps Structure des données : un bit de démarrage + 8 bits de données + un ou plus d'un bit d'arrêt, pas de parité. Interface USB : USB B femelle
Alimentation :	DC 7,5V±10 / 2A
Température de fonctionnement :	5 °~40 ° C/humidité relative : 10 %~80%
Température de stockage :	-20 °~ 60 ° C/humidité relative : 10 %~90 %
Dimensions :	13,8 x 20 x 12 cm (L x l x H)
Poids :	375 g (sans rouleau de papier inséré)

INTRODUCCIÓN

Este manual de usuario le muestra cómo instalar y usar su impresora de recibos térmica Safescan TP-230. Le recomendamos que lea minuciosamente estas instrucciones de funcionamiento y que conserve este manual como referencia para el futuro. Para obtener más información, consulte www.safescan.com.

CONTENIDO DE LA CAJA

La caja del producto contiene los elementos siguientes:

- Impresora de recibos Safescan TP-230
- Adaptador de alimentación (7,5V/2A)
- Papel de impresora
- Cable USB (USB-B a USB-A)
- Guía de instalación rápida

PRODUCTO

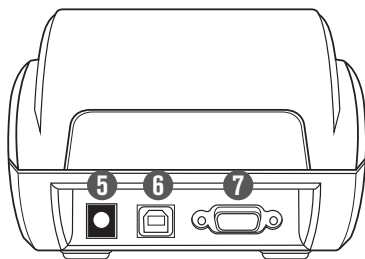
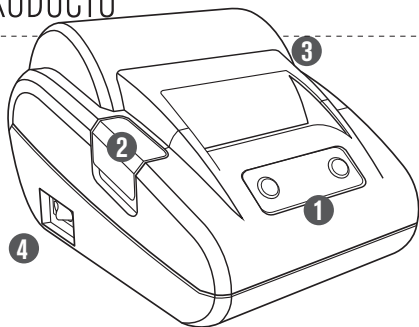

PARTE DELANTERA

1. Panel de operación
2. Botón de apertura de tapa
3. Tapa del papel
4. Interruptor de encendido y apagado

PARTE TRASERA

5. Conexión de alimentación
6. Conector USB
7. Conector serie (RS-232)
8. Papel para impresión térmica

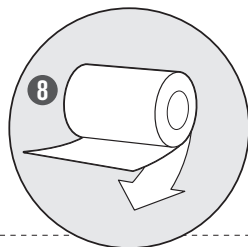

INSTALACIÓN DEL PAPEL DE IMPRESIÓN

1. Abra la tapa presionando el botón

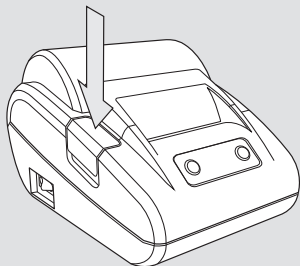

2. Coloque el rollo de papel de la forma que se muestra

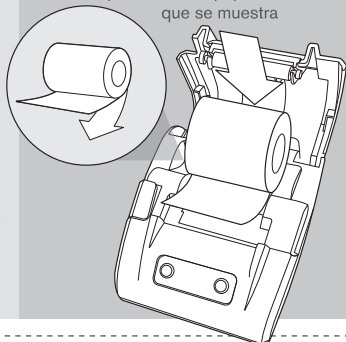

3. Cierre la tapa

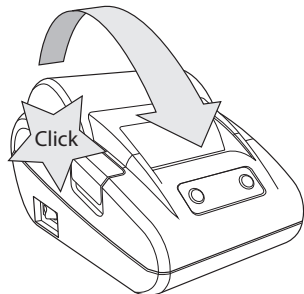

CONEXIÓN DE LA IMPRESORA

1. Conecte el adaptador de alimentación a la impresora y al enchufe de la red eléctrica

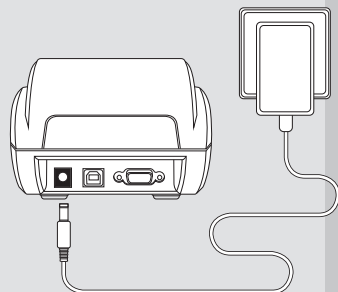

2. Conecte la impresora a su dispositivo mediante el puerto USB (se suministra el cable) o puerto serie

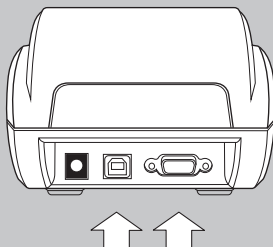

3. Encienda el dispositivo

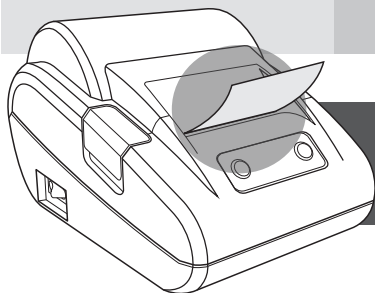
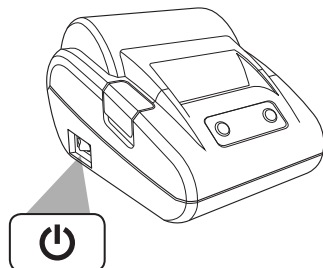

TENGA EN CUENTA LO SIGUIENTE: ANTES DE USAR EL DISPOSITIVO HAY QUE TIRAR DEL PAPEL HASTA QUE SOBRESALGA Y ESTÉ VISIBLE FUERA DE LA IMPRESORA

BOTONES E INDICADORES LED

1. Botón SET; utilice este botón para navegar por los parámetros de la impresora, por ejemplo la interfaz, el idioma y el tamaño de la fuente.
2. Indicador LED POWER; indica que la impresora está encendida.
3. Indicador LED ERROR; parpadeará cuando se produce un error.
4. Botón FEED; utilice este botón para alimentar el papel y seleccionar la configuración de parámetros.

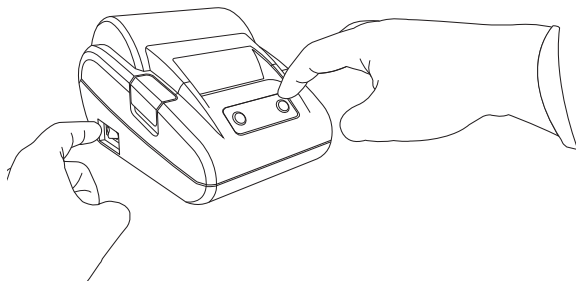
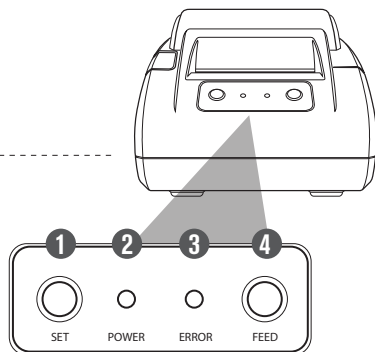

AUTOCOMPROBACIÓN DE LA IMPRESORA

Mantenga pulsado el botón FEED mientras enciende la impresora. Se imprimirá en ese momento el recibo de autocomprobación.

CAMBIO DE LA CONFIGURACIÓN DE PARÁMETROS DE LA IMPRESORA

Usando los botones SET y FEED puede navegar por los diversos menús de configuración de parámetros. La impresora mostrará que campo de selección ha sido seleccionado imprimiendo ese parámetro.

PASO 1, ENTRAR EN MODO DE CONFIGURACIÓN

A. Apagar el dispositivo

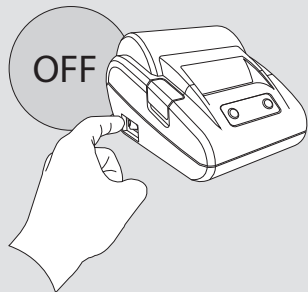

B. Pulsar simultáneamente los botones SET y FEED

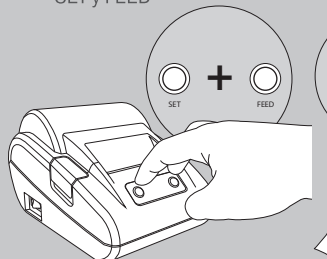

El indicador LED rojo de error parpadeará.

C. Encender el dispositivo. Mantener pulsados los botones SET y FEED

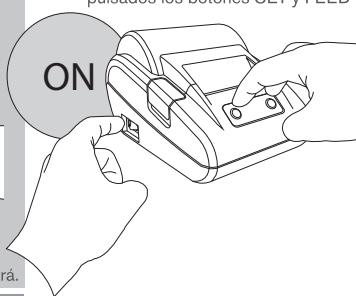

D. Deje de pulsar el botón FEED mientras continúa pulsando SET

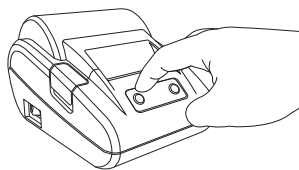

E. Pulse FEED dos veces mientras continúa pulsando SET

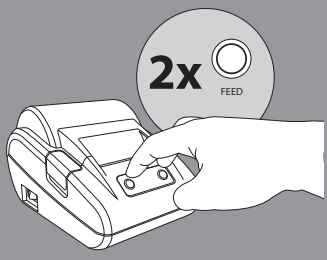

F. Deje de pulsar el botón SET

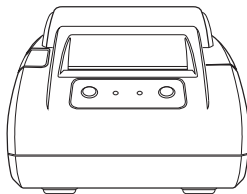

La impresora está ahora en el **modo de configuración de parámetros** e imprimirá el primer parámetro del menú de configuración.

PASO 2, SELECCIONE EL PARÁMETRO QUE DESEE CAMBIAR.

Al pulsar el botón SET, podrá desplazarse por los diversos elementos que pueden modificarse. Esta secuencia constituye un bucle y es la siguiente:

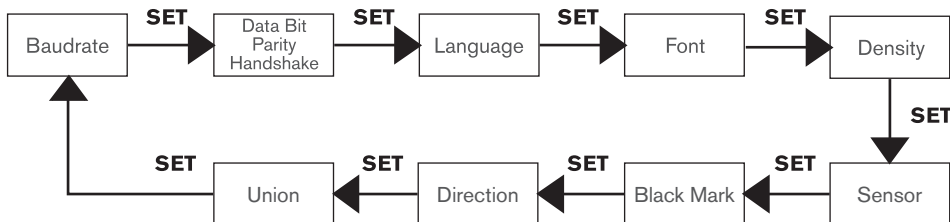
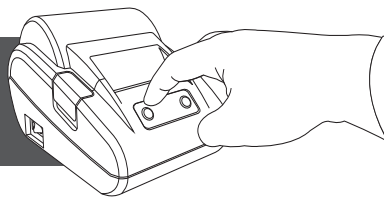

Cada vez que pulse SET, el papel impreso mostrará qué parámetro está seleccionado y su configuración actual. El paso siguiente muestra cómo cambiar la configuración.

PASO 3. CAMBIE EL AJUSTE DEL ELEMENTO SELECCIONADO

Cuando se encuentre en la configuración de un elemento que desee cambiar, podrá seleccionar el valor deseado pulsando el botón FEED. Cada vez que pulse FEED, se imprimirá el valor aplicable. La secuencia constituye un bucle y es la siguiente:

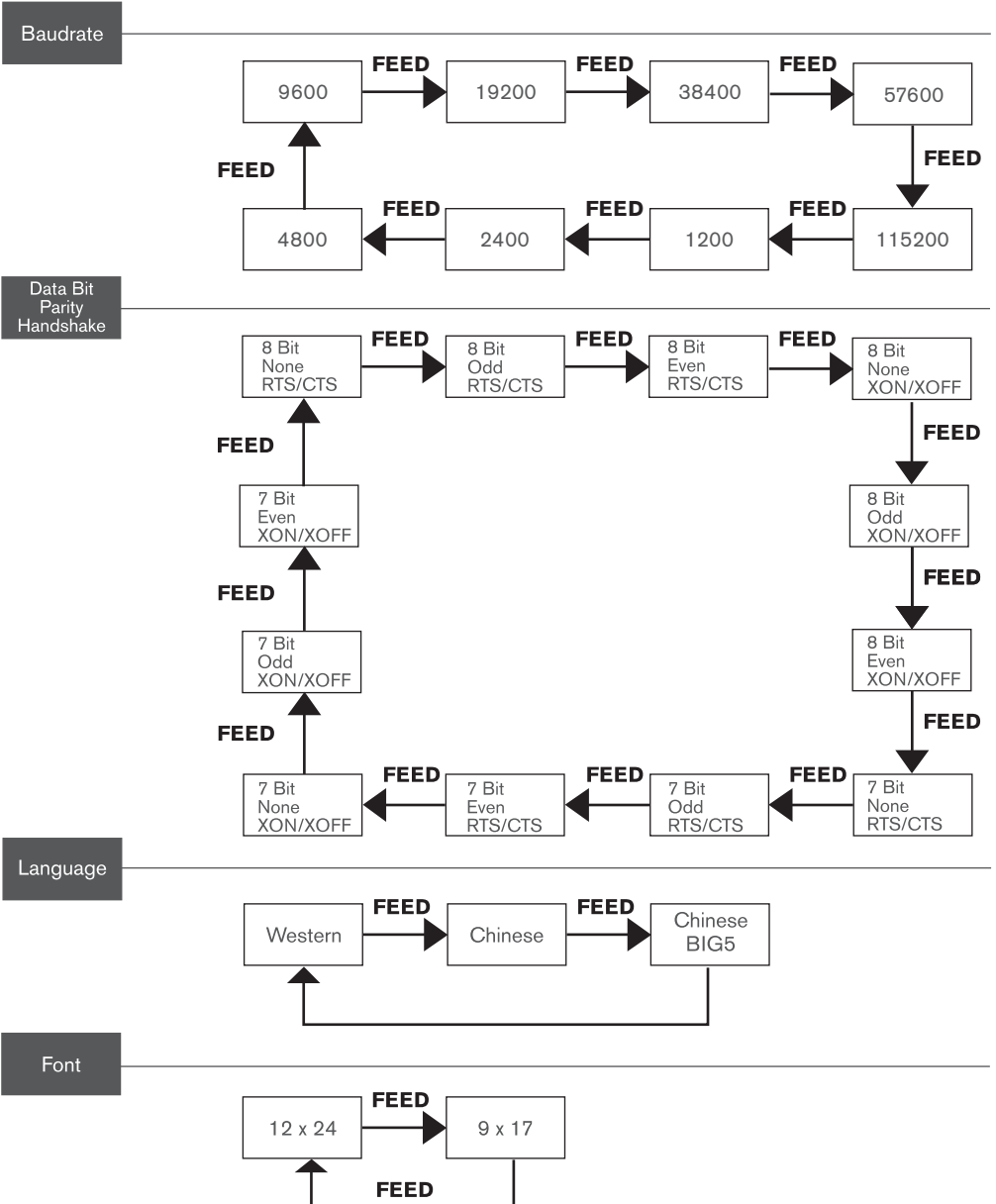

Density

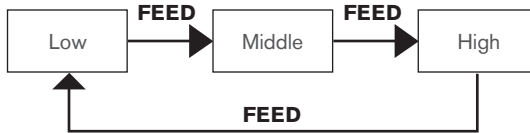

Sensor



Black mark

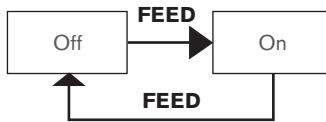

Direction

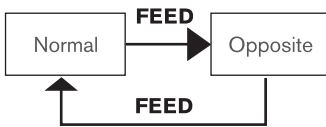

Union of orders



PASO 4. GUARDAR LA CONFIGURACIÓN

Si no se han guardado los cambios, la impresora volverá a la configuración predeterminada después de haber sido apagada. Para guardar la configuración.

A. Pulse los botones SET y FEED

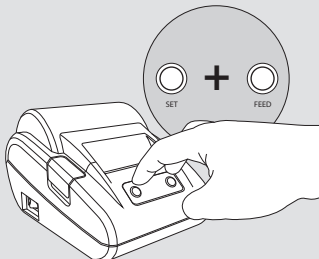

B. Suelte el botón FEED mientras continúa pulsando el botón SET

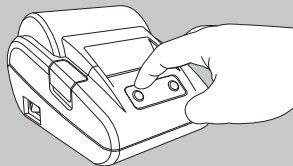

C. Suelte el botón SET

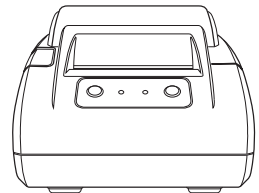

El papel impreso ahora mostrará **Exit Set mode**. Se ha guardado la configuración.

CONEXIONES DE PIN POR CABLE SERIE

En el caso de que necesite conectar el dispositivo Safescan TP-230 a un dispositivo servidor mediante un cable serie RS 232 (no se suministra), los detalles de configuración del pin serán los siguientes:

PIN	SEÑAL	RECURSO	DESCRIPCIÓN
2	TXD	Impresora	Impresora a servidor enviar código de control X-ON/X-OFF y datos
3	RXD	Host	Impresora recibiendo datos del servidor
5	GND	--	Conexión a tierra de la señal
6	DSR	Impresora	CTS
8	CTS	Impresora	La señal para el estado "MARK": impresora "ocupada" no recibiendo datos; y la señal para el estado "SPACE": impresora "lista", puede recibir datos.

ASISTENCIA TÉCNICA

¿ALGUNA PREGUNTA? ¿NECESITA ASISTENCIA TÉCNICA?

Compruebe primero si el adaptador de alimentación y el cable de datos están conectados correctamente y si el papel de imprimir se ha insertado correctamente. Nuestro equipo de asistencia técnica está disponible por teléfono durante las horas de oficina (zona horaria GMT +1) o por correo electrónico para responder a cualquier pregunta que pueda tener con relación al uso de su dispositivo Safescan. Para obtener más información, consulte el sitio web www.safescan.com.

Cuando llame o envíe un correo electrónico a nuestro centro de asistencia técnica, asegúrese de tener siempre a mano la siguiente información: número de modelo, número de pieza, número de serie (véase la pegatina del producto en la parte inferior del dispositivo), número de la versión del software y, fecha de compra.

ESPECIFICACIONES TÉCNICAS

Método de impresión:	térmico directo
Papel de impresora:	anchura 58 mm, grosor 0,06 ~ 0,08 mm
Diámetro del rollo de papel:	máx. 60 mm
Anchura de impresión real:	48 mm
Resolución de impresión:	8 puntos / mm, 203 ppp, 384 puntos / línea
Velocidad de impresión:	60 mm/s

Interfaz:	Interfaz RS232 : serie DB25, compatible con protocolo RTS/CTS Velocidad de transmisión (baudios): 2400, 4800, 9600, 19200, 38400, 57600, 115200bps Estructura de datos: un bit de inicio + 8 bits de datos + uno o más de un bit de parada, sin paridad. Interfaz USB : USB B hembra
-----------	---

Fuente de alimentación:	CC de 7,5V±10 / 2A
-------------------------	--------------------

Temperatura de funcionamiento:	5° ~ 40° C / humedad relativa: 10% ~80%
Temperatura de almacenamiento:	-20° ~ 60° C / humedad relativa: 10% ~90%

Dimensiones:	13,8 x 20 x 12 cm (Long x Anch x Alt)
Peso:	375 g (sin el rollo de papel insertado)

INTRODUZIONE

Questo manuale spiega come installare e utilizzare la stampante termica per ricevute TP-230 Safescan. Leggere attentamente queste istruzioni operative e conservare il manuale per riferimento futuro. Per ulteriori informazioni, consultare www.safescan.com.

CONTENUTO DELLA CONFEZIONE

La confezione contiene i seguenti elementi:

- Stampante per ricevute TP-230 Safescan
- Adattatore di alimentazione (7,5 V/2 A)
- Carta da stampa
- Cavo USB (da USB-B a USB-A)
- Guida rapida all'installazione

PRODOTTO

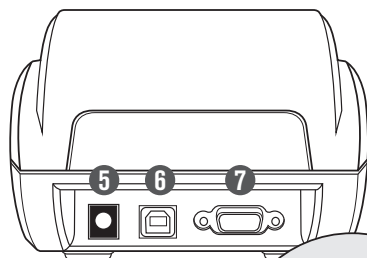
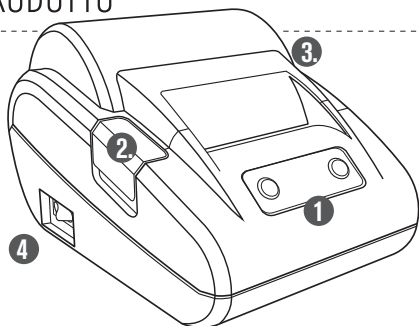

FRONTE

1. Pannello operativo
2. Pulsante apertura coperchio
3. Coperchio carta
4. Interruttore di alimentazione

RETRO

5. Presa alimentazione
6. Connettore USB
7. Connettore seriale (RS-232)
8. Carta da stampa termica

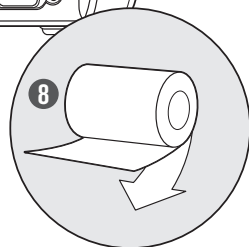

INSTALLAZIONE DELLA CARTA DA STAMPA

1. Aprire il coperchio premendo il pulsante

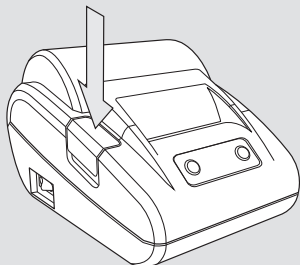

2. Posizionare il rotolo di carta come illustrato

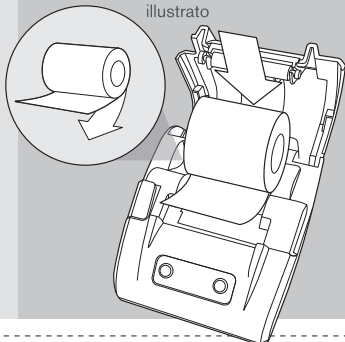

3. Chiudere il coperchio

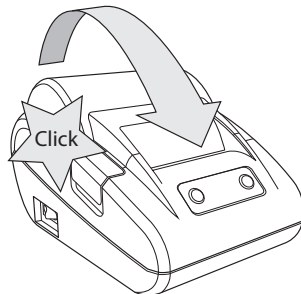

COLLEGAMENTO DELLA STAMPANTE

1. Collegare l'adattatore di alimentazione alla stampante e alla presa di corrente

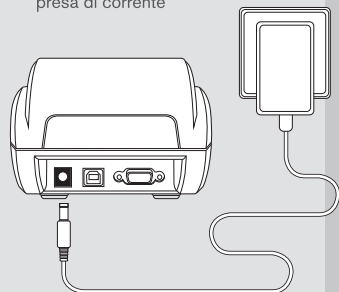

2. Collegare la stampante al proprio dispositivo tramite USB (cavo in dotazione) o la porta seriale

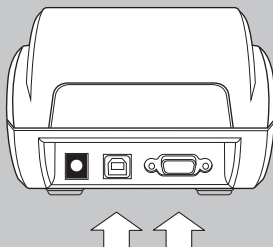

3. Attivare l'alimentazione

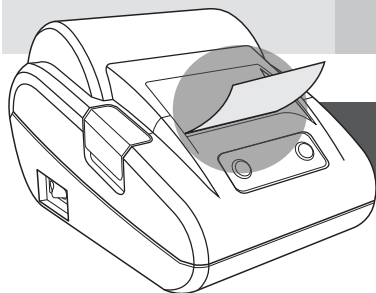
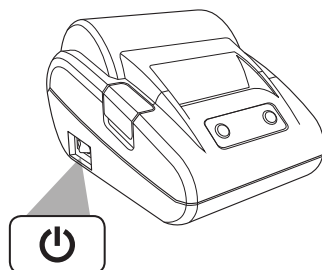

SI NOTI: LA CARTA DEVE ESSERE ESTRATTA FINO A ESSERE VISIBILE ALL'ESTERNO DELLA STAMPANTE PRIMA DELL'USO

PULSANTI E INDICATORI LED

1. Pulsante SET; utilizzare questo pulsante per navigare tra i parametri della stampante, come interfaccia, lingua e dimensione carattere.
2. Led POWER; indica che la stampante è accesa.
3. Led ERROR; lampeggia quando si verifica un errore.
4. Pulsante FEED; utilizzare questo pulsante per alimentare la carta e per selezionare le impostazioni dei parametri.

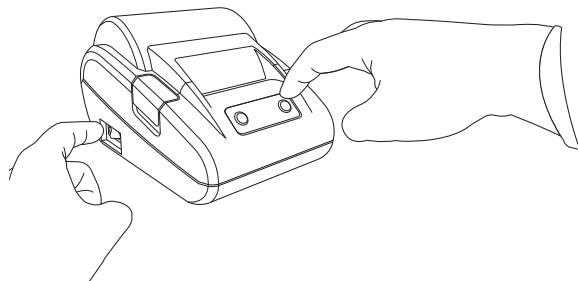
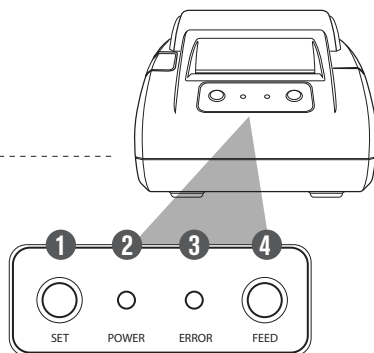

AUTO TEST DELLA STAMPANTE

Premere e tenere premuto il pulsante FEED quando si accende l'alimentazione della stampante. La ricevuta di auto test viene ora stampata automaticamente.

MODIFICA DELLE IMPOSTAZIONI PARAMETRI DELLA STAMPANTE

Utilizzando i pulsanti SET e FEED è possibile navigare attraverso i vari menu di impostazione dei parametri. La stampante mostrerà quale campo di selezione è stato selezionato stampando il parametro selezionato.

PUNTO 1. ACCEDERE ALLA MODALITÀ DI IMPOSTAZIONE

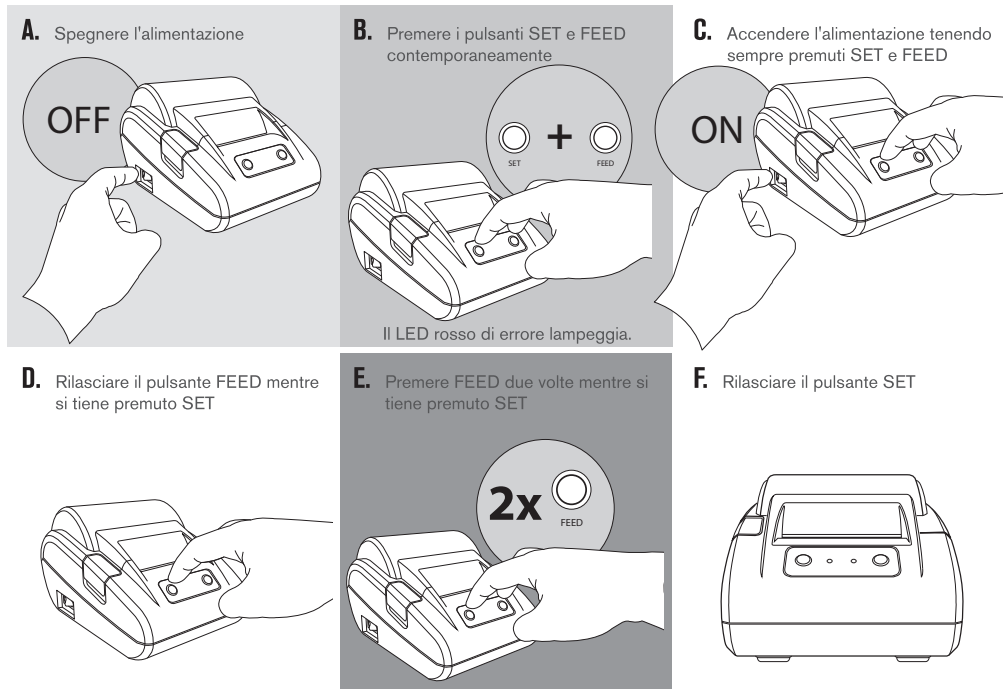

La stampante è ora in **Modalità di impostazione parametri** e stamperà il primo parametro del menu impostazioni.

PUNTO 2. SELEZIONARE IL PARAMETRO CHE SI DESIDERA

Premendo SET, è possibile scorrere le varie voci che possono essere modificate. Questa sequenza è un ciclo ed è la seguente:

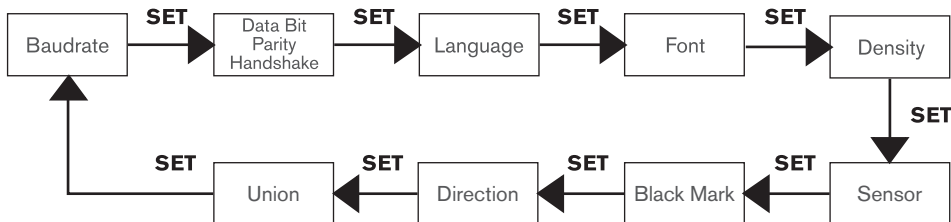

Ogni volta che si preme SET, lo stampato mostrerà quale parametro è selezionato, più la sua impostazione corrente. Il punto successivo mostra come modificare l'impostazione.

PUNTO 3. MODIFICARE L'IMPOSTAZIONE DELLA VOCE SELEZIONATA

Quando ci si trova nell'impostazione per la voce che si desidera modificare, il valore desiderato può essere selezionato premendo FEED. Ogni volta che si preme FEED, il valore applicabile verrà stampato. Le sequenze sono un ciclo e sono le seguenti:

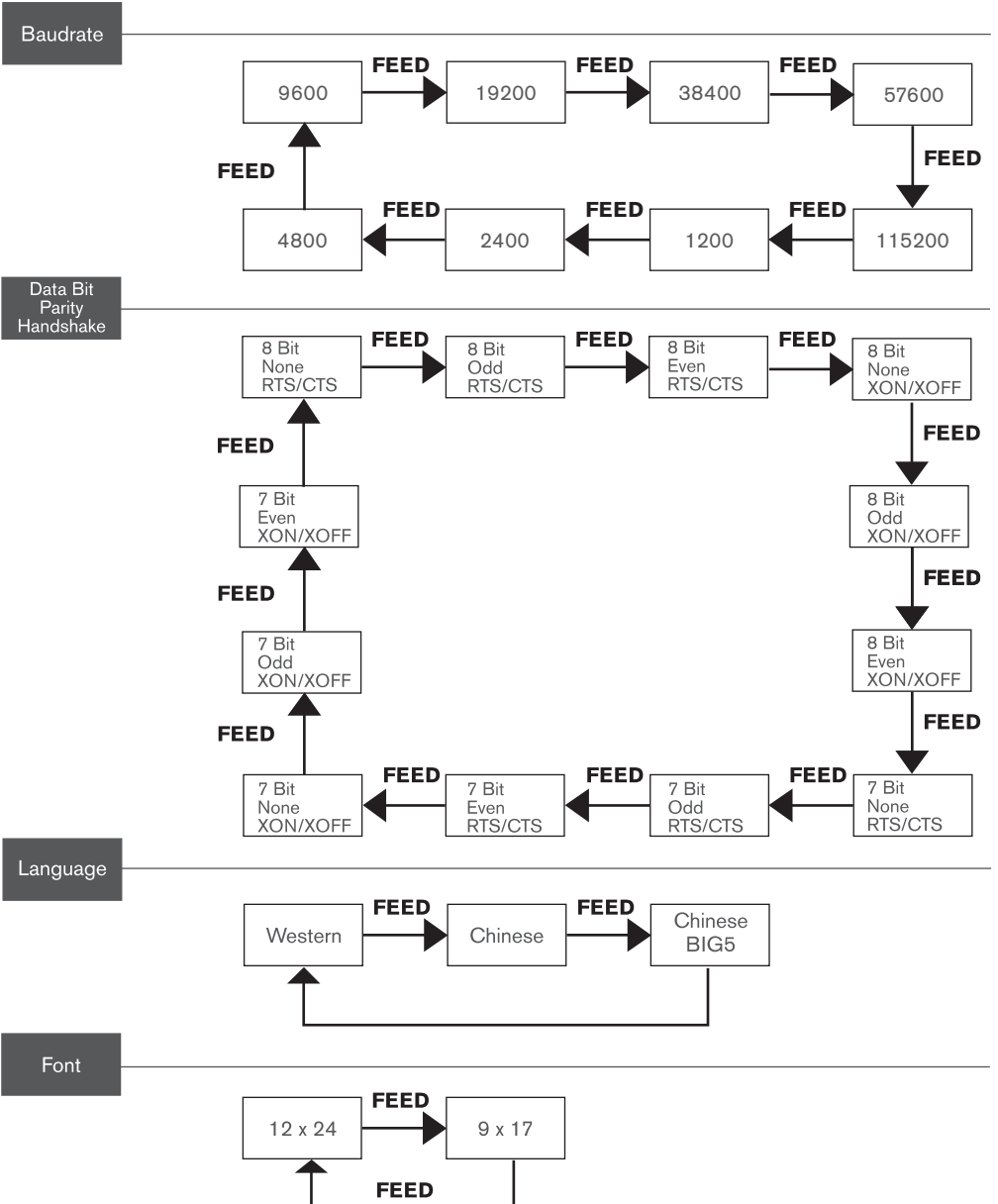

Density

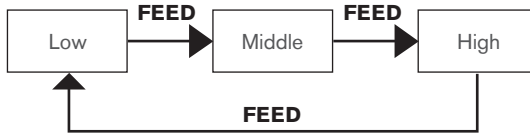

Sensor

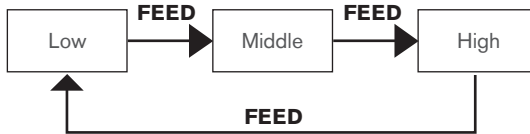

Black mark

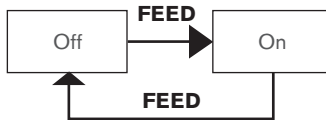

Direction

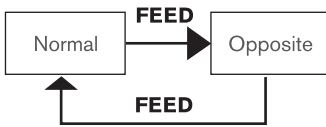

Union of orders



PUNTO 4. SALVATAGGIO DELLE IMPOSTAZIONI

Se le modifiche non vengono salvate, la stampante tornerà alle impostazioni di default dopo essere stata spenta. Per salvare le impostazioni:

A. Premere contemporaneamente i pulsanti SET e FEED

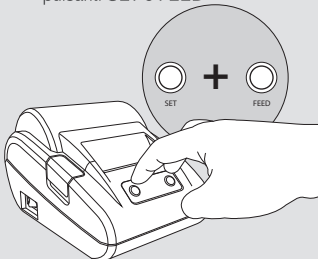

B. Rilasciare FEED continuando a tenere premuto SET

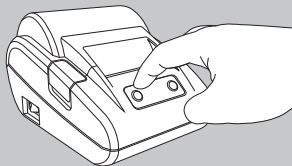

C. Rilasciare il pulsante SET

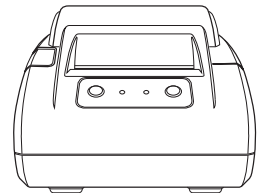

Lo stampato mostrerà ora **Exit Set mode**. Le impostazioni sono state salvate.

CONNESSIONI PIN CAVO SERIALE

Nel caso in cui sia necessario collegare Safescan TP-230 con un cavo seriale RS 232 (non in dotazione) a un dispositivo host, il formato di configurazione pin è il seguente:

PIN	SEGNALE	RISORSA	DESCRIZIONE
2	TXD	Stampante	Invio da stampante a host di codice di controllo X-ON/X-OFF e dati
3	RXD	Host	La stampante riceve i dati dall'host
5	GND	--	Terra segnale
6	DSR	Stampante	CTS
8	CTS	Stampante	Il segnale per lo stato "MARK" - stampante "occupata", cioè non sta ricevendo i dati, e il segnale per lo stato "SPACE" - stampante "pronta", cioè in grado di ricevere i dati.

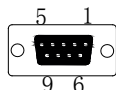

SUPPORTO

DOMANDE? HAI BISOGNO DI ASSISTENZA TECNICA?

Controllare prima se l'adattatore di alimentazione e il cavo dati sono collegati correttamente, e se la carta da stampa è stata inserita correttamente. Il nostro team di supporto tecnico è disponibile per telefono in orario di ufficio (fuso orario GMT +1) o via e-mail per rispondere a qualsiasi domanda relativa all'utilizzo del dispositivo Safescan. Visitare www.safescan.com per i dettagli.

Prima di contattare telefonicamente o tramite e-mail il nostro centro di assistenza, verificare sempre di avere a portata di mano le seguenti informazioni: numero di modello, numero componente, numero di serie (riportato sull'adesivo del prodotto, sul fondo del dispositivo), versione del software, data di acquisto.

SPECIFICHE TECNICHE

Metodo di stampa: Carta da stampa Diametro rotolo carta: Larghezza di stampa effettiva: Risoluzione di stampa: Velocità di stampa:	termico diretto larghezza 58 mm, spessore 0,06 ~ 0,08 mm max. 60 mm 48 mm 8 dot/mm, 203 dpi, 384 dot/linea 60 mm/s
Interfaccia:	Interfaccia RS232 : seriale DB25, supporta protocollo RTS/CTS Velocità in baud: 2400, 4800, 9600, 19200, 38400, 57600, 115200 bps Struttura dei dati: un bit di start + 8 bit di dati + uno o più bit di stop, nessuna parità.
	Interfaccia USB : USB B femmina
Alimentazione:	CC 7,5 V ± 10 / 2 A
Temperatura operativa:	5° ~ 40° C / umidità relativa: 10% ~80%
Temperatura di conservazione:	-20° ~ 60° C / umidità relativa: 10% ~90%
Dimensioni:	13,8 x 20 x 12 cm (L x P x A)
Peso:	375 g (senza rotolo di carta inserito)

INTRODUÇÃO

Este manual mostra como instalar e utilizar a sua impressora térmica de recibos Safescan TP-230. Leia atentamente estas instruções de funcionamento e guarde este manual para consulta futura. Para mais informações consulte www.safescan.com.

CONTEÚDO DA EMBALAGEM

A embalagem contém os seguintes itens:

- Impressora de recibos Safescan TP-230
- Transformador (7.5V/2A)
- Cabo USB (USB-B para USB-A)
- Guia de instalação rápida
- Papel para impressão

PRODUTO

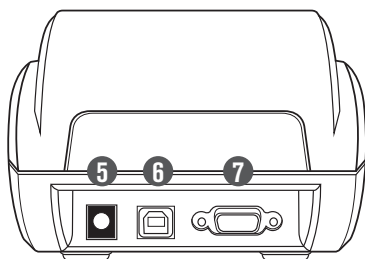
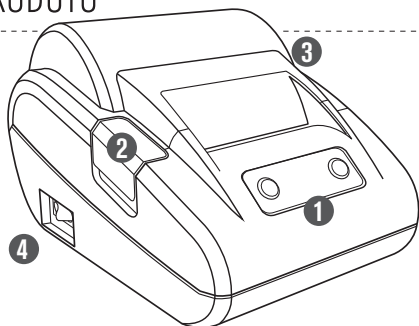

FRENTE

1. Painel de operação
2. Botão para abrir a tampa
3. Tampa do papel
4. Interruptor de alimentação

PARTE POSTERIOR

5. Tomada de alimentação
6. Conector USB
7. Conector (RS-232) de série
8. Papel de impressão térmico

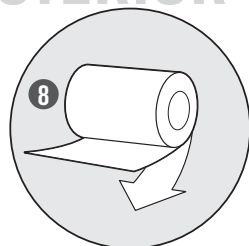

INSTALAR O PAPEL PARA IMPRESSÃO

1. Abra a tampa, premindo o botão

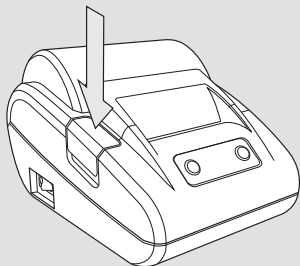

2. Coloque o rolo de papel, conforme ilustrado

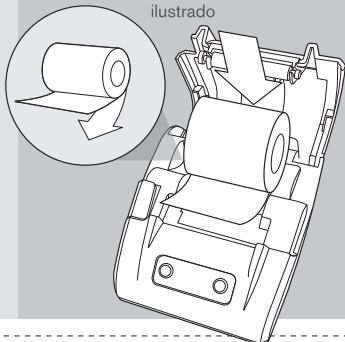

3. Feche a tampa

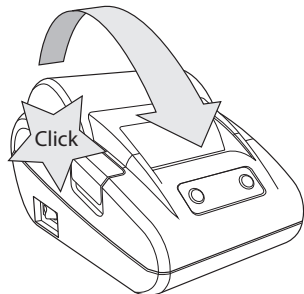

LIGAR A IMPRESSORA

1. Conecte o transformador à impressora e à tomada de eletricidade

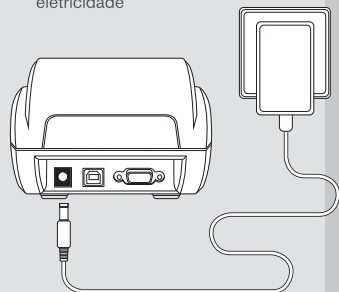

2. Conecte a impressora ao seu dispositivo através da porta USB (cabo fornecido) ou de série

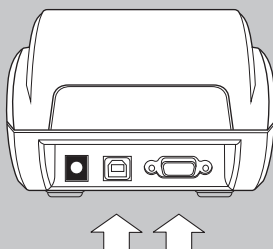

3. Ligue a alimentação

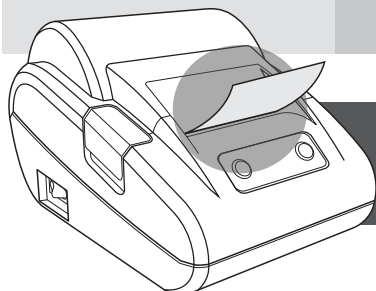
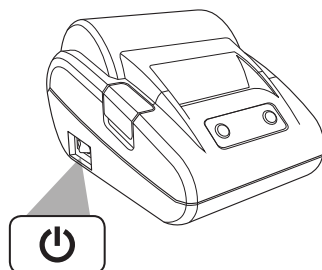

TENHA EM ATENÇÃO: O PAPEL TEM DE SER PUXADO PARA FORA ATÉ QUE SEJA VISÍVEL DO LADO DE FORA DA IMPRESSORA ANTES DA UTILIZAÇÃO

BOTÕES E INDICADORES LED

1. SET botão de definição, utilize este botão para navegar pelos parâmetros da impressora, tais como a interface, o idioma e o tamanho do tipo de letra.
2. POWER led de alimentação; indica que a impressora está ligada.
3. ERROR led de erro; pisca quando ocorre um erro.
4. FEED botão de alimentação; utilize este botão para alimentar o papel e selecionar configurações de parâmetros.

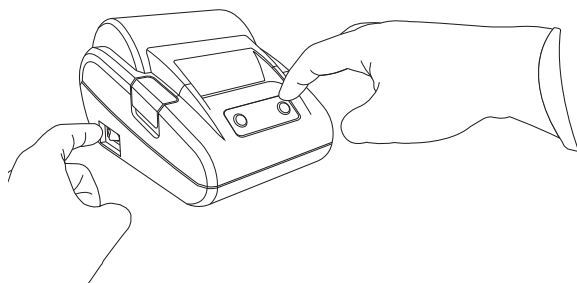
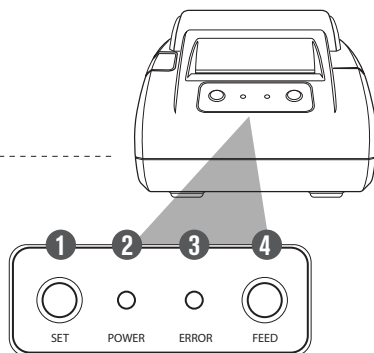

AUTOTESTE DA IMPRESSORA

Prima e mantenha premido o botão FEED quando ligar a energia da impressora. O recibo de autoteste será agora automaticamente impresso.

ALTERAR AS DEFINIÇÕES DE PARÂMETROS DA IMPRESSORA

Ao utilizar os botões SET e FEED pode navegar por vários menus de definição de parâmetros. A impressora mostrará que campo de seleção foi selecionado por si imprimindo o parâmetro selecionado.

PASSO 1. ENTRAR NO MODO DE DEFINIÇÃO

A. Desligue a alimentação

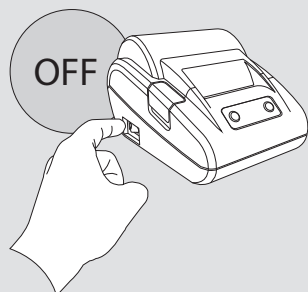

B. Prima os botões SET e FEED simultaneamente

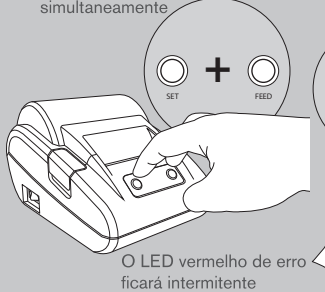

C. Ligue a alimentação. Mantenha premidos SET e FEED

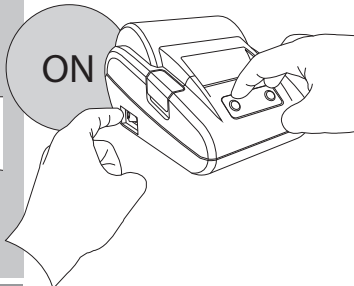

D. Liberte o botão FEED mantendo o botão SET premido

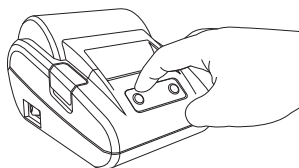

E. Prima FEED duas vezes enquanto mantém SET premido

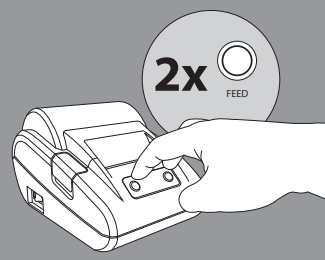

F. Liberte o botão SET

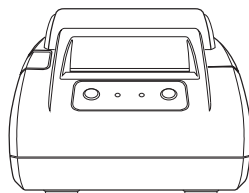

A impressora está agora no **Modo de configuração de parâmetros** e imprimirá o primeiro parâmetro do menu de definições.

PASSO 2. SELECIONE O PARÂMETRO QUE DESEJA ALTERAR

Premindo SET, pode percorrer os vários itens que podem ser alterados. Esta sequência constitui um ciclo e é como se segue:

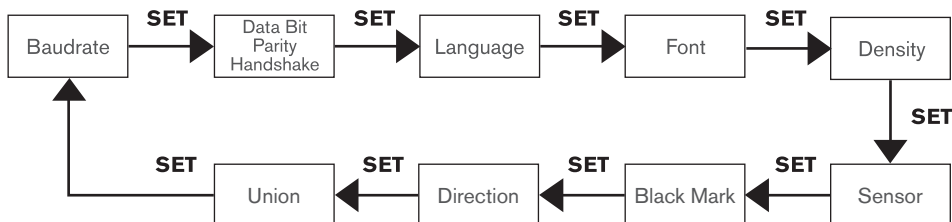
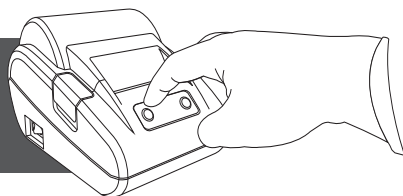

Cada vez que prime SET, a impressão mostrará que parâmetro está selecionado, além da sua configuração atual. O próximo passo mostra como alterar a configuração.

PASSO 3. ALTERAR A DEFINIÇÃO DO ITEM SELECIONADO

Assim que se encontrar na definição do item que deseja alterar, o valor desejado pode ser selecionado premindo **FEED**. Cada vez que prime **FEED**, o valor aplicável será impresso. As seqüências constituem um ciclo e são como se segue:

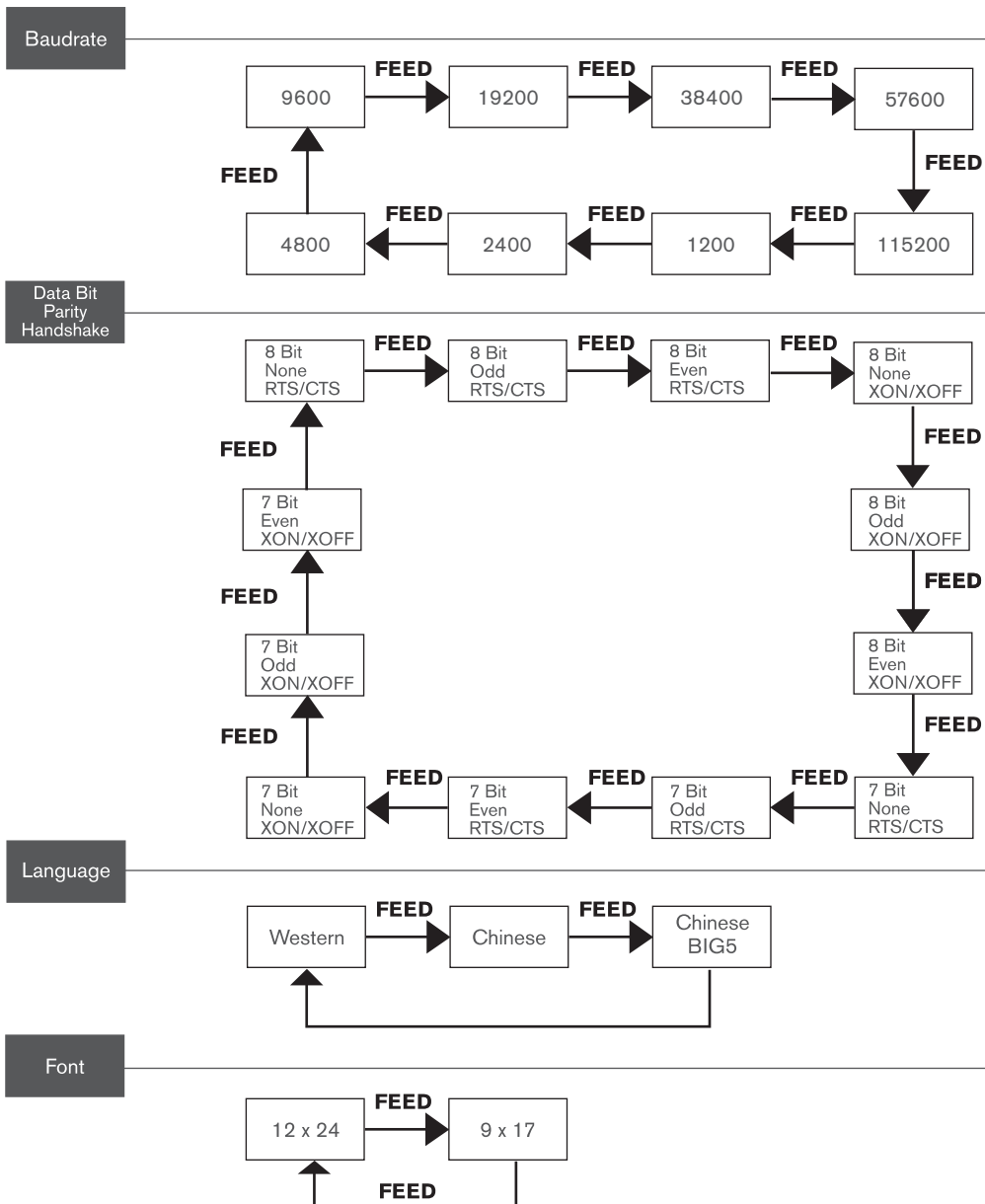

Density

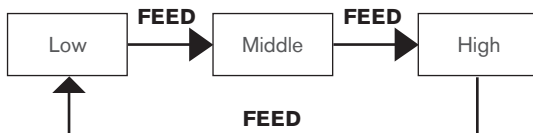

Sensor

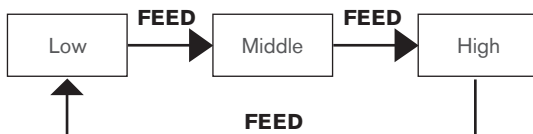

Black mark

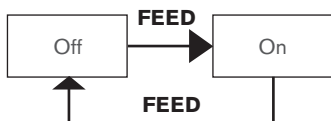

Direction

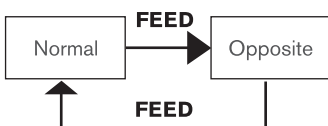

Union of orders

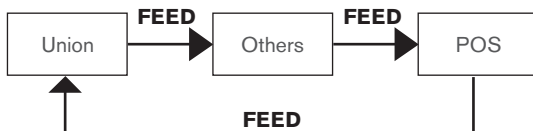

PASSO 4. GUARDAR AS DEFINIÇÕES

Quando as alterações não são guardadas, a impressora voltará às configurações predefinidas depois de ter sido desligada. Para guardar as definições:

A. Prima os botões SET e FEED
botão

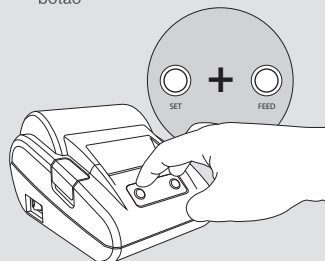

B. Liberte FEED mantendo premido SET

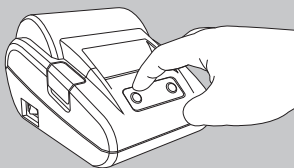

C. Liberte o botão SET

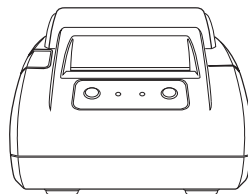

A impressão mostrará agora **Exit Set mode**. As configurações foram guardadas.

CONEXÕES DE PIN DE CABO DE SÉRIE

No caso de precisar de conectar a sua Safescan TP-230 com um cabo de série RS 232 (não fornecido) a um dispositivo anfitrião, o layout da configuração de pin é a seguinte:

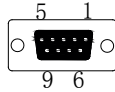
PIN		SINAL	RECURSO	DESCRIÇÃO
2		TXD	Impressora	Impressora para anfitrião, enviar código de controlo X-ON/X-OFF e dados
3		RXD	Anfitrião	A impressora recebe dados do anfitrião
5		GND	-	Sinal baixo
6		DSR	Impressora	STC
8		STC	Impressora	O sinal para o estado "MARK" - impressora "ocupada", não recebe dados e o sinal para o estado "SPACE" - impressora "pronta", pode receber dados.

APOIO

ALGUMA DÚVIDA? PRECISA DE ASSISTÊNCIA TÉCNICA?

verifique primeiro se o transformador e o cabo de dados estão conectados de forma adequada e se o papel de impressão foi inserido corretamente. A nossa equipa de apoio técnico está disponível por telefone durante o horário de expediente (fuso horário TMG+1), ou por e-mail para responder a qualquer dúvida que possa ter em relação à utilização do seu dispositivo Safescan. Visite www.safescan.com para mais pormenores.

Quando telefonar ou enviar um e-mail para o nosso centro de apoio, certifique-se de que tem sempre à mão as seguintes informações: número do modelo, número de peça, número de série (ver a etiqueta do produto, na parte inferior do dispositivo), número da versão do software, data de compra.

ESPECIFICAÇÕES TÉCNICAS

Método de impressão:	térmica direta
Papel para impressão	largura 58 mm, espessura de 0,06 ~ 0,08 mm
Diâmetro do rolo de papel:	max. 60 mm
Largura de impressão real:	48 mm
Resolução de impressão:	8 pontos/mm, 203dpi, 384 pontos/linha
Velocidade de impressão:	60 mm/s

Interface	Interface RS232: DB25 de série, suporta protocolo RTS/CTS Velocidade de transmissão: 2400, 4800, 9600, 19200, 38400, 57600, 115200bps Estrutura de dados: um bit de início + 8 bits de dados + um ou mais de um bit(s) de paragem, sem paridade. Interface USB: USB B fêmea
-----------	--

Fonte de alimentação:	DC7.5V±10 / 2A
-----------------------	----------------

Temperatura de funcionamento:	5° ~ 40° C / humidade relativa: 10% ~80%
Temperatura de armazenagem:	-20° ~ 60° C / humidade relativa: 10% ~90%

Dimensões:	13.8 x 20x12 cm (C x L x A)
Peso:	375 g (sem rolo de papel inserido)



Aluminiumstraat 65
2718 RB Zoetermeer
The Netherlands
T. +31 (0)79 3631170
E. info@safescan.com